

BSP-1200 - BENCH-SCALE ULTRASONIC LIQUID PROCESSOR

USER MANUAL

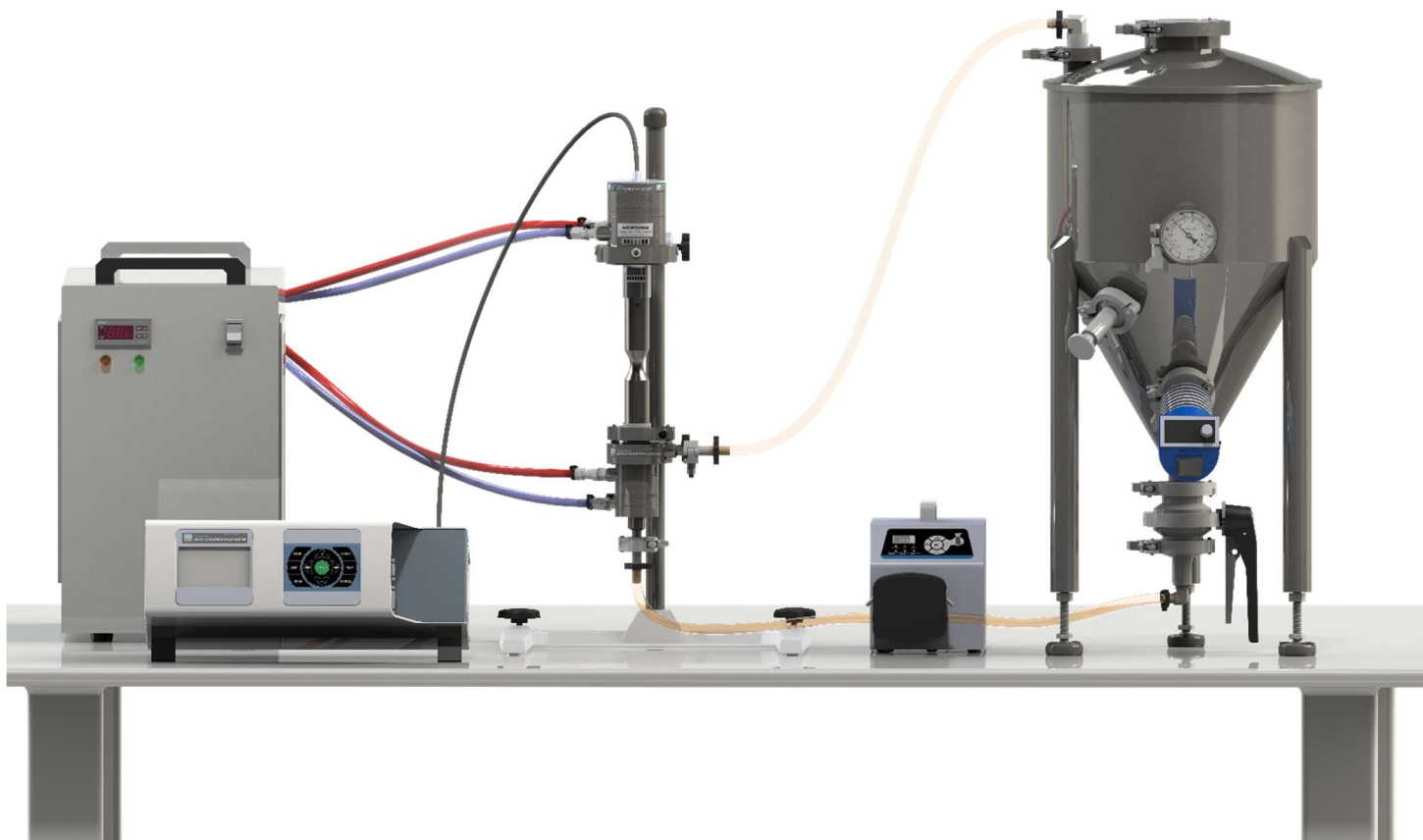

Notice of Liability:

The information contained in this manual is distributed on an “as is” basis, without warranty. While every precaution has been taken in the preparation of this manual, the manufacturer shall not be liable to any person or entity with respect to any liability, loss, or damage caused or alleged to be caused directly or indirectly by the instructions contained in this manual or by the products described herein.

Patent Protection:

This ultrasonic equipment is manufactured under U.S. Patent No. 7,156,201, International Patent Application No. PCT/US2008/068697, U.S. Patent No. 8,651,230, U.S. Patent No. 9,142,751, U.S. Patent No. 11,325,094, U.S. Patent No. 12,005,417.

Table of Contents

SECTION 1, INTRODUCTION	4
GENERAL USER INFORMATION.....	5
<i>Read This Manual First</i>	5
<i>Notes, Cautions and Warnings</i>	5
SYSTEM OVERVIEW	5
Generator	5
Transducer	6
Barbell Horns®	6
Reactor Chamber (Flow Cell)	6
SYSTEM PRODUCTIVITY	6
BATCH MODE.....	7
FLOW-THROUGH MODE	8
SECTION 2, HEALTH AND SAFETY	9
GENERAL CONSIDERATIONS	10
ELECTRICAL SAFETY.....	10
Power Grounding	10
SECTION 3, GENERATOR INSTALLATION, CONNECTIONS & LAYOUT	11
UNPACKING	12
PLACING.....	12
GENERATOR CHASSIS AND CONNECTIONS	13
<i>AC Power Inlet Panel</i>	14
<i>Connecting System Cables</i>	15
<i>RFI Grounding</i>	15
<i>Proper Handling of Cable Slack</i>	15
Power Switch/Circuit Breaker	15
SYSTEM INPUT/OUTPUT Connector	15
Ultrasound Output Connector	17
OPERATING KEYS AND DISPLAY OVERVIEW.....	18
SECTION 4, SYSTEM ASSEMBLY, TESTING AND OPERATION	19
SWCT-1200 ULTRASONIC TRANSDUCER.....	20
ULTRASONIC HORN.....	21
<i>Attaching the Horn to the Transducer</i>	23
<i>Detaching the Horn from the Transducer</i>	24
REACTOR CHAMBER (RC-BSP-1200).....	25
<i>Assembling the Reactor Chamber with a Barbell Horn®</i>	26
<i>Disassembling the Reactor Chamber from a Barbell Horn®</i>	28
OPERATING AND BATCH-MODE TESTING.....	29
<i>Main Functions – ON, OFF, SCAN, AMP, TIME, START, STOP</i>	29
<i>Testing</i>	32
SECTION 5, MAINTENANCE & TROUBLESHOOTING	34
GENERAL MAINTENANCE.....	35
<i>Horn Maintenance</i>	35
<i>System Cleaning Instructions</i>	35
TROUBLESHOOTING	36
SECTION 6, SPECIFICATIONS	41
GENERATOR SPECIFICATIONS	41
<i>Drawings</i>	41
<i>Generator Weight</i>	42

<i>AC Power Requirements</i>	42
<i>Regulatory Agency Compliance</i>	42
SPECIFICATIONS FOR ULTRASONIC STACK AND PERIPHERAL COMPONENTS	43
SECTION 7, APPENDIX	44
I. SCAN STACK PROCEDURE	45
II. PIN LAYOUT AND DESCRIPTIONS FOR SYSTEM I/O PORT (J5)	47
III. SYSTEM TO SPECIFICATION TESTING AND STACK BENCHMARKING	51
<i>Test in air</i>	51
<i>Test in water (batch mode)</i>	51
<i>Test in water (flow-through mode)</i>	51
<i>Ultrasonic Stack Power and Frequency Benchmarking</i>	52

Section 1

Introduction

General User Information

Read This Manual First

Before operating your ultrasonic processor, read this User Manual to become familiar with the equipment. This will ensure correct and safe operation. The manual is organized to allow you to learn how to safely operate this processor. The examples given are chosen for their simplicity to illustrate basic operation concepts.

Notes, Cautions and Warnings

Throughout this manual, we use NOTES to provide information that is important for the successful application and understanding of the product.

In addition, we use special notices to make you aware of safety considerations. These are the CAUTION and WARNING blocks as shown here. They have important information that, if ignored, could have increasingly severe outcomes. These statements help you to identify and avoid hazards and recognize the consequences. One of three different symbols also accompany the CAUTION and WARNING blocks to indicate whether the notice pertains to a condition or practice, an electrical safety issue or an operator protection issue.

Failure to follow any of the statements in the WARNING or CAUTION blocks will void this product's warranty.

System Overview

The BSP-1200 bench-scale ultrasonic liquid processor is designed for process optimization and medium-scale production. It outputs up to 1,200 W of acoustic power into the processed liquids and operates at the frequency of approximately 20 kHz. The processor is supplied with four primary ultrasonic components: 1,200 W **ultrasonic generator**, **sealed water-cooled transducer**, **Barbell Horn®** and optional **reactor chamber** (flow cell).

Generator

The 1,200 W **generator** has rugged internal circuitry and ensures a continuous resonant frequency lock during operation. The LCD display can be used to change the settings for the ultrasonic amplitude, starting frequency and ramp-up or ramp-down parameters. Constant amplitude is provided, regardless of the power draw, which is automatically adjusted to compensate for variable loading conditions. The ultrasonic vibration amplitude level can be adjusted from 20 to 100 %. The generator passes strict CE test specifications for global applications (see Section 6).

NOTE

Note statements provide additional information or highlight procedures.

CAUTION



Caution statements identify conditions or practices that could result in damage to the equipment or other property.

WARNING



Warning statements point out conditions or practices that could result in personal injury or loss of life.



Condition or Practice



Electrical Hazard



Hearing Protection

Transducer

The BSP-1200 processor includes a water-cooled **piezoelectric transducer**, SWCT-1200. This transducer has a power rating of 1,200 W, can operate continuously (see CAUTION and WARNING, below) and is sealed to the outside environment, which makes it immune to high-humidity conditions and suitable for processing flammable materials, such as fuels and organic solvents.

CAUTION



The SWCT-1200 transducer must be cooled with water. The water flow rate must be at least 5 L/min and its temperature must be below 15 °C/59 °F (8 – 10 °C/46 – 50 °F is recommended). Operating the unit without the cooling water may cause irreversible damage and is strictly prohibited.

In no event can the transducer's front mass (area just above where the transducer meets the horn) be allowed to exceed 54 °C (129 °F).

WARNING



Do not use any solvents or flammable liquids to cool the transducer. Such liquids may destroy the cooling jacket's seals and penetrate into the internal area of the transducer, causing an electrical short and resulting in irreversible damage to sensitive components and/or harm to the operator.

Barbell Horns®

Several **Barbell Horn®** types may be utilized with the BSP-1200 (see Figure 11). The Half-booster Half-wave Barbell Horn® (HBHB) can be used in the flow-through and batch processing modes, while the Full-wave Barbell Horn® (FBH) is only appropriate for the batch processing mode. The horns have large output tip diameters (typically, 30 - 35 mm) and can deliver high vibration amplitudes of up to 80 - 100 microns (µm). The amplitude is calibrated by a high-precision photonic sensor. The ability to reach high amplitudes at the bench scale gives investigators a wide range of ultrasonic exposure parameters. When optimal conditions are established, the process can be transferred to a large-volume commercial scale by implementing our ISP-3600 industrial-scale ultrasonic liquid processor.

Reactor Chamber (Flow Cell)

The BSP-1200 processor can operate in two processing modes: **batch** and **flow-through** (see Figure 1 and Figure 2, respectively). With the use of the **reactor chamber** (flow cell), the processor can be configured for continuous liquid processing in the flow-through mode. When a large amount of material needs to be processed, this arrangement is preferable to the batch mode because it results in a much higher processing capacity, improved ultrasonic exposure uniformity and better temperature stability. During continuous ultrasonic processing, the use of the reactor chamber ensures that all processed liquid is directed through the active cavitation zones created by the incorporated HBHB-type horn, resulting in homogeneous processing and high product quality. The reactor chamber supplied with the BSP-1200 processor includes a water-cooling jacket to help maintain the temperature of the processed liquid at the desired level.

System Productivity

Productivity rates provided by the BSP-1200 processor are highly dependent on the nature of each process and range from about 1 L/h for challenging tasks (e.g., top-down nano-crystallization of active pharmaceutical ingredients) to over 100 L/h for fast processes (e.g., degassing). When used for the production of nanoemulsions, the productivity rate of approximately 5 L/h can be expected.

Batch Mode

Batch mode (see Figure 1) processing does not require the reactor chamber. In this mode, the processed liquid is placed in a batch container. The batch mode is commonly used for ultrasonic degassing of oils, paints, epoxies and other liquids as well as for general process investigations. Transducer cooling with chilled water is required when processing in the batch mode. Please contact ISM for further details on the peripheral items offered with the BSP-1200.

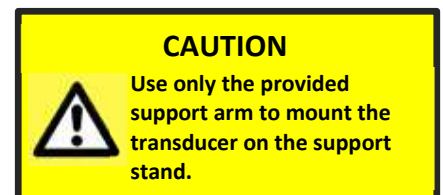
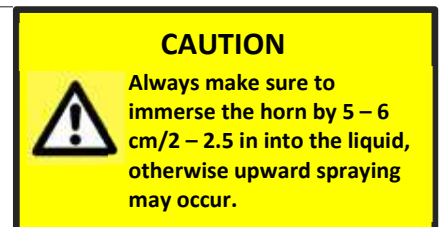
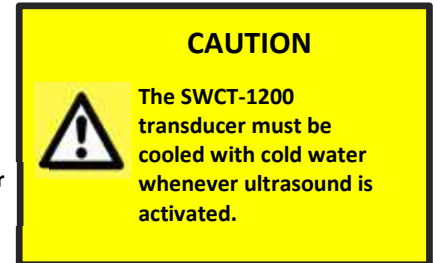
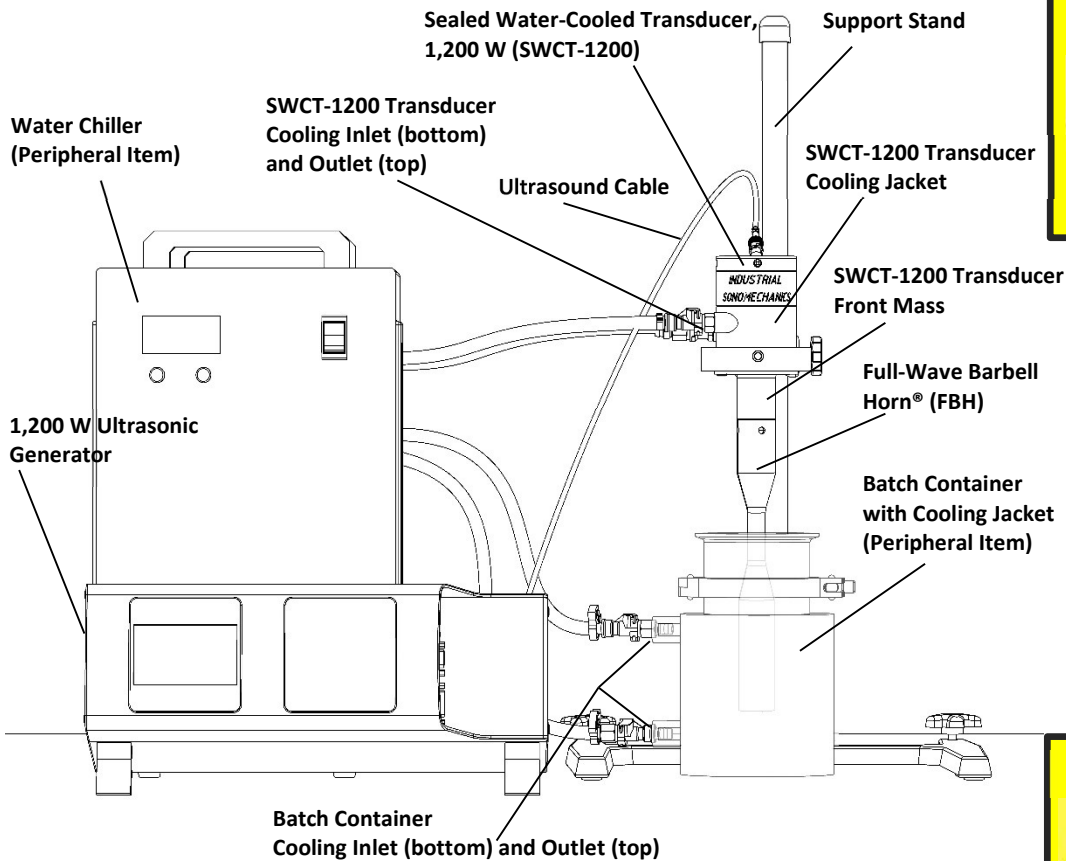

Figure 1. BSP-1200 ultrasonic processor configured in the batch mode. The 1,200 W ultrasonic generator excites vibration in the SWCT-1200 transducer. The vibration amplitude is amplified by the FBH-type Barbell Horn®, and the ultrasonic energy is delivered to the liquid in the batch container. The horn is immersed into the liquid to its nodal point (to the depth of about 5 – 6 cm/2 – 2.5 in). Batch sizes of up to about 2 L can commonly be processed using this setup directly. Larger batches may require that the processed liquid be independently mixed. The liquid may be cooled by using a batch container with a cooling jacket.

Flow-Through Mode

Recirculating and **single-pass** configurations are possible with the **flow-through** processing mode. In the recirculating configuration (see Figure 2), the material passes through the reactor chamber multiple times, which increases the cumulative exposure time. The single-pass configuration is commonly used as part of multistep processing involving different modalities. In this configuration, the processed liquid coming from a previous processing step passes through the reactor chamber, after which it is either collected as the final product or continues down the line for further processing. Please contact ISM for further details on the peripheral items offered with the BSP-1200.

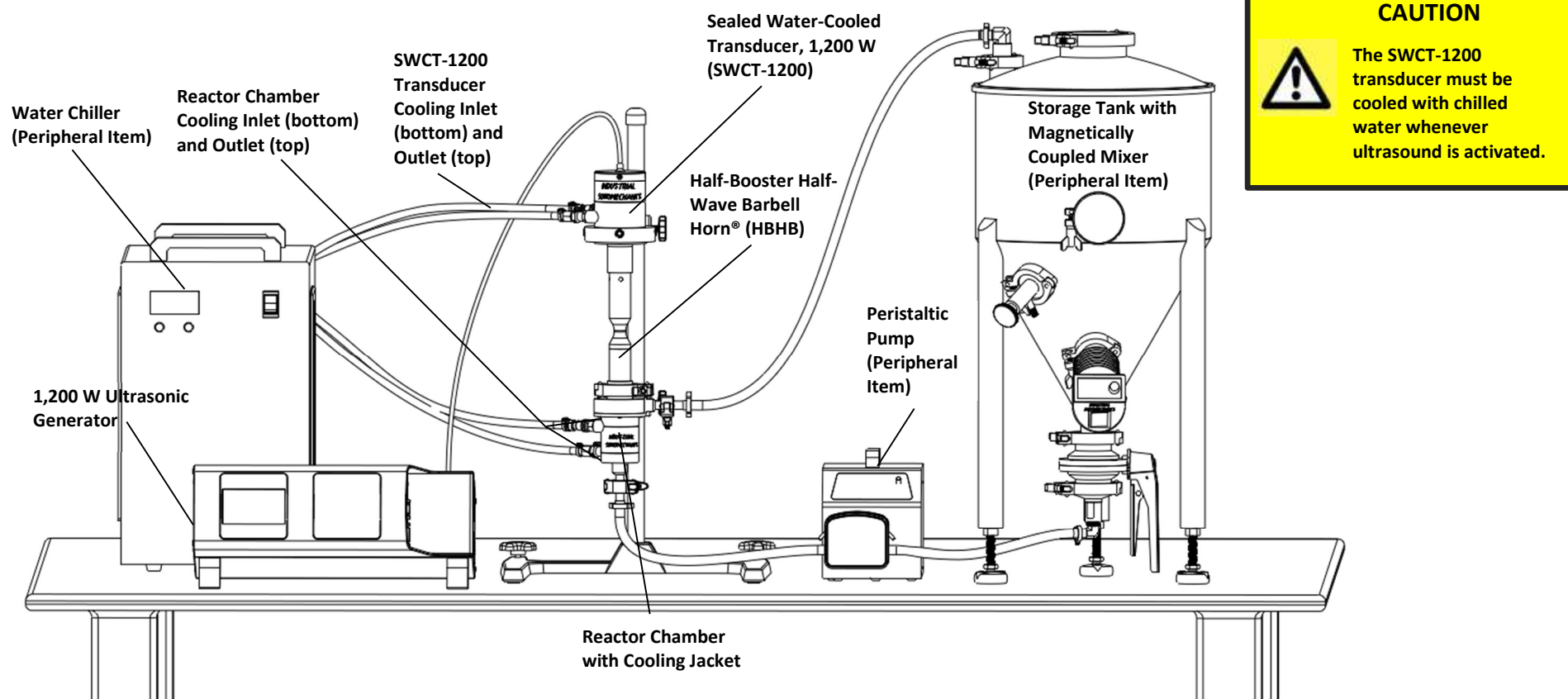

Figure 2. BSP-1200 ultrasonic processor configured in the recirculation flow-through mode. The 1,200 W ultrasonic generator excites vibration in the SWCT-1200 transducer. The vibration amplitude is then amplified by the HBHB-type Barbell Horn®, and the ultrasonic energy is delivered to the liquid flowing through the reactor chamber. Typical liquid volumes processed with this setup are 5 – 20 L, although much large volumes can be processed as well, with no upper limit.

Section 2

Health and Safety

General Considerations

Please observe these health and safety recommendations for safe, efficient, and injury-free operation of your equipment.

CAUTION

 **Proper Installation** – Operate system components only after they are properly installed and checked.

 **Comply with Regulations** – You may be required to add accessories to bring the system into compliance with applicable OSHA regulations for machine guarding and noise exposure.

 **Avoid physical damage** - Do not drop, hit or strain any component of the ultrasonic processor.

 **Stay Alert** – Watch what you are doing at all times. Use common sense. Do not operate the system when you are tired, under the influence of illicit drugs or alcohol, taking prescription medication or distracted from the job at hand.

WARNING

 **No Unauthorized Modifications** – Do not modify your system in any way unless authorized to do so by the manufacturer. Unauthorized modifications may cause injury to the operator and/or equipment. Unauthorized modifications will void equipment warranty.

 **Keep the Cover On** – Do not remove any equipment cover unless specially directed to do so by the manufacturer. The generator produces hazardous electrical voltages, which could cause injury.

 **Grounded Electrical Power** – Operate this equipment only with a properly grounded electrical connection. (See the *Electrical Safety* section below).

WARNING

 Wear ear protection to reduce the noise emitted during ultrasonic processing. In addition, sound absorbing materials, enclosures or sound deflectors may be installed to reduce the noise level.

WARNING

 If there is any question about the grounding of your receptacle, have it checked by a qualified electrician. Do not cut off the power cord grounding prong or alter the plug in any way. If an extension cord is needed, use a three-wire cord that is in good condition. The cord should have an adequate power rating to do the job safely. It must be plugged into a grounded receptacle. Do not use a two-wire extension cord with this product.

Electrical Safety

Power Grounding

For safety, the 1,200 W ultrasonic generator has a three-wire, grounding-type power cord. Figure 3 illustrates the grounded plug options available with the power cord (120 or 240 VAC, 15 Amp for USA and 240 VAC, 16 Amp for Continental Europe).

120 VAC Plug



240 VAC Plug



240 VAC Plug (Continental Europe)



WARNING

 If you have a two-prong electrical receptacle, replace it with a properly grounded three-prong type. Have a qualified electrician replace it following the National Electric Code and any local codes and ordinances that apply.

Figure 3. 120 and 240 VAC-rated grounded plugs available with the generator power cord.

SECTION 3

Generator Installation, Connections & Layout

Unpacking

Carefully open your shipping container and make sure it contains all items shown on the shipping documents. Inspect all items and report any damage immediately.

Placing

Make certain the generator placement and cable routing allow for easy access and that they do not interfere with normal operation. The operator should have unobstructed access to all control switches and a clear view of the LCD screen and operating keys. When placing the generator, allow at least 13 cm (5 in) of space on each side of the generator chassis for air circulation.

WARNING



Do not allow any liquid or mist to enter the internal area of the generator in any way, for example, through its air inlet or outlet. This may cause an electrical short.

CAUTION



Allow for at least 13 cm/5 in of space on each side of the generator for ventilation. The cooling fan must be allowed to easily draw in fresh air to cool the internal components, reduce thermal gradients and increase generator components' life span.

Generator Chassis and Connections

Schematics of the side and rear views of the generator are presented in Figure 4 and Figure 5, respectively. Descriptions of each item on the side and rear of the generator are provided in Table 1 .

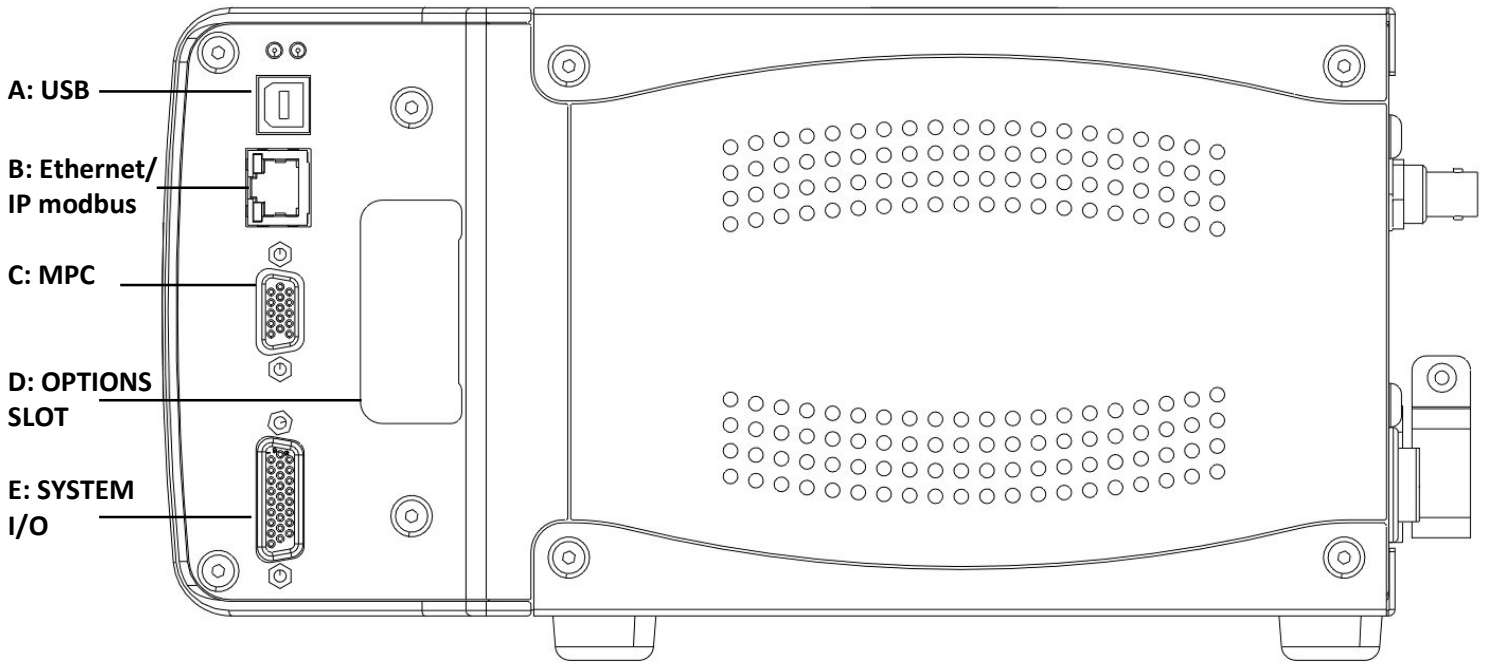

Figure 4. Side view of the generator.

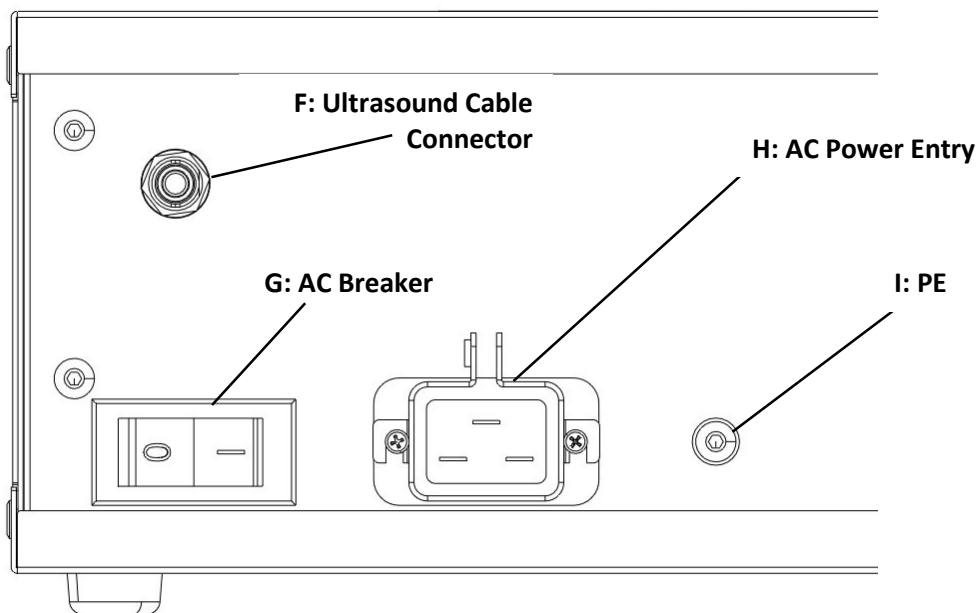

Figure 5. Rear view of the generator.

Letter	Description
A	Configuration Port Connector – digital control port used to modify system parameters.
B	Ethernet/IP Connector – provides for communication between the generator and an automation network.
C	Multi-Point Control Connector – used to connect an MPC module.
D	An optional module can be installed here.
E	System Input/Output Connector – connections for system control input signals and system status output signals.
F	Ultrasound Output Connector – coaxial high-voltage connection to ultrasound cable.
G	Power Switch/Circuit Breaker – used to switch system power ON and OFF.
H	IEC Power Inlet Connector – attaches to an IEC-style power cord.
I	Chassis Grounding Stud – chassis connection for a protective earth ground (RFI grounding).

Table 1. Description of items on the side and rear of the generator.

AC Power Inlet Panel

The AC line cord supplied with the 1,200 W generator is matched to the ultrasonic output power rating and the continent of specified use, as described in Table 2.

Continent of Use	Power Cord Part No.	Power Rating
North America	200 – 1109	120 V, 15 Amp
	200 – 1110	240 V, 15 Amp
Continental Europe	200 – 1111	240 V, 16 Amp

Table 2. Power cord options provided with the generator.

WARNING



The generator power cord is equipped with a three-prong, grounded-type plug for your safety. If you have a two-prong receptacle, replace it with a properly grounded three-prong type. Have a qualified electrician make the replacement in accordance with the National Electrical Code and local codes and ordinances. **DO NOT** cut off the power cord grounding prong or alter the plug in any way.

Connecting System Cables

1. Attach the ultrasound cable between the transducer and the ultrasound output connector (**F** in Figure 5).
2. Connect the supplied AC power cord to the generator's IEC power inlet connector (**H** in Figure 5) and plug the other end into an approved AC outlet.

RFI Grounding

In addition to the safety considerations previously mentioned, proper grounding via the generator's power cord is essential for the effective suppression of electrical noise or RFI (Radio Frequency Interference). Every ultrasonic generator contains an RFI filter which blocks noise on the AC power line from entering the system control circuitry. This filter also prevents ultrasonic frequency noise from being fed back into the AC power line. In order for the RFI filter to operate most efficiently, it is recommended to also connect the system to an independent ground.

Run the supplied green 14-gauge wire from the ground stud connection (**I** in Figure 5) to the nearest grounded metal pipe or equivalent earth ground and secure it with a ground clamp.

Proper Handling of Cable Slack

When taking up slack in cables, the extra length should be coiled up (see left-side of Figure 6) rather than folded (see right-side of Figure 6).



Figure 6. Proper cable slack take-up.

Avoid excessive tension and bends. Cables should be routed such that there are no abrupt bends in the cables, especially near their connectors.

Power Switch/Circuit Breaker

The power switch/circuit breaker has a rocker type actuator switch that will activate or deactivate the AC power to the system. The power **ON** position is marked with the internationally recognized **I** symbol, the power **OFF** position is marked with the **O** symbol. This power switch also integrates an appropriately sized over-current protection circuit breaker in the generator.

If an over-current condition trips the circuit breaker, it will automatically switch to the **OFF** position. If the circuit breaker trips due to a transient condition, it can be reset by switching the actuator back to the **ON** position. If after resetting the circuit breaker it immediately trips again, an internal system malfunction is likely, and the generator will require service. Do not repeatedly try to reset the circuit breaker to avoid causing more damage to the generator.

SYSTEM INPUT/OUTPUT Connector

The SYSTEM INPUTS/OUTPUTS (I/O) connector (**E** in Figure 4) mounted on the system I/O panel includes connections for all basic system control input and output signals that will typically be associated with an automated control system. A

cable attached to this connector includes all available system control signals, which can be controlled by an output card or output port on a controller.

The user can determine which signals to use and monitor for their application, however, there must be at least two connections made to this connector, otherwise the generator will always be in an E-STOP condition (ultrasound will not initiate). These two connections are made by default with the 26-pin serial adapter (HD-26M) that was provided with your generator. Only an engineer or technician comfortable with designing and operating controllers should attempt to utilize the generator's automated control capabilities. If the E-STOP condition is not removed, then you will not be able to initiate ultrasonic processing and the warning message shown in Figure 7 will be displayed.

NOTE

Only a well-trained technician or engineer should remove the 26-pin serial adapter (HD-26M) provided with your ultrasonic generator.

All of the I/O signals on this connector are electrically isolated (signals are NOT referenced to chassis ground). Inputs are activated when there is a 24 Vdc difference between the Input pin and the Input Common pin. The electrically isolated I/O signals can be activated/monitored from an automation controller with either sinking (NPN) or sourcing (PNP) I/O depending upon how the isolated common connection is terminated. All inputs sink or source 10 mA of current from a 24 Vdc power supply. The total output current cannot exceed 500 mA when using the +22 Vdc generator output (pin 1). If an external supply is used, the maximum current for each output is 400 mA.

The SYSTEM I/O connector is a HD-26F (high density D-subminiature 26 circuit female) connector. For details on custom automation system wiring and assembly at this connector, see Appendix II.

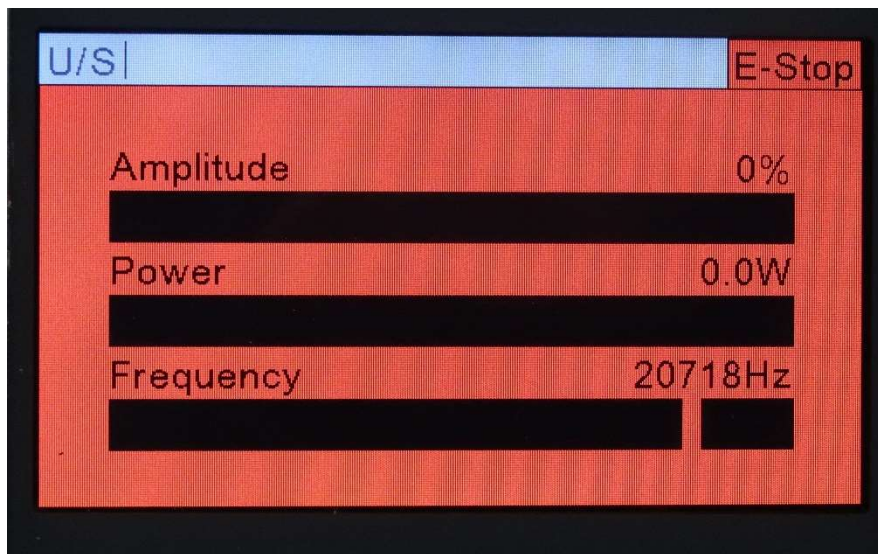



Figure 7. Generator display in the event that E-STOP condition is not removed.

Ultrasound Output Connector

The ultrasound output connector is a high-voltage (5,000 V) coaxial style SHV-BNC connector. This connector provides superior shielding of electrical noise compared to other types of connectors. The ultrasound output connector mates with a fully shielded coaxial ultrasound cable that is secured with a simple and reliable quarter-turn bayonet style attachment mechanism.

WARNING



The ultrasonic output from this connector (that drives the attached ultrasonic load) has a very high AC voltage. At high power levels, the output can also exceed 2 amperes of current. It must be securely terminated via the ultrasound cable for safe operation. Use original equipment ultrasound cables for safe and reliable system operation. Improperly assembled ultrasound cables can result in high voltage arcing, which can destroy the ultrasound connectors.

Do not use your generator if there is any evidence of arcing (black carbon deposits) on either the ultrasound output connector or the ultrasound cable connectors.



Figure 8. Ultrasound output connector.

WARNING



Make sure to always connect the ultrasound cable to both the transducer and generator. Do not activate ultrasound if the cable is not connected to both devices.

Operating Keys and Display Overview

This section provides an overview of the operating keys and LCD display (see Figure 9 and Table 3).

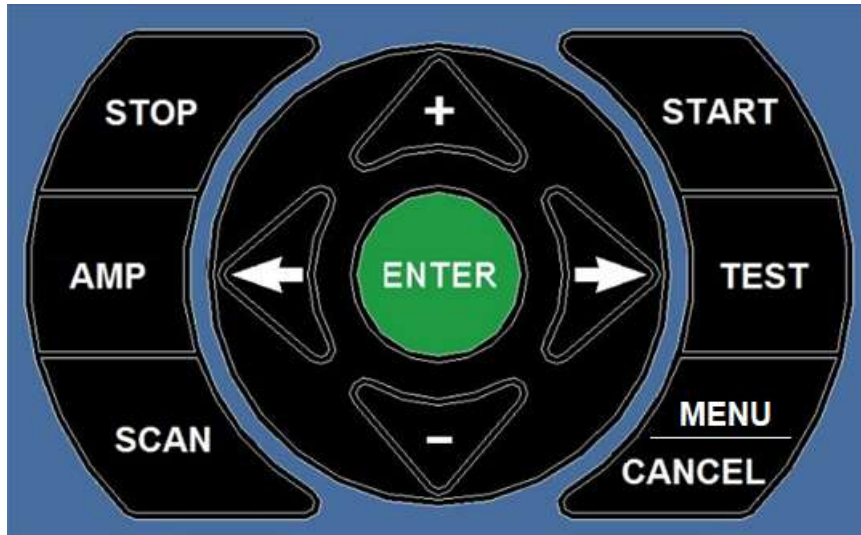

Figure 9. Front panel operating keys.

KEY	FRONT PANEL
ENTER	Confirm/Accept Menu Options and Clear Alarms (page 36)
+ / -	Navigate Up and Down on Display
← / →	Navigate Left and Right on Display
STOP	Stop Ultrasonic Output
START	Start Ultrasonic Output
AMP	Select and Set Ultrasonic Amplitude (% of maximum)
TEST	Test Ultrasonic Stack (HOLD to initiate ultrasound)
SCAN	Perform Scan Stack Procedure
MENU/CANCEL	Go to Menu/Cancel Selection and Go to Main Screen

Table 3. Description of front panel operating keys.

SECTION 4

System Assembly, Testing and Operation

SWCT-1200 Ultrasonic Transducer

Ultrasonic transducers convert the electric energy coming from an ultrasonic generator into mechanical energy in the form of ultrasonic vibrations.

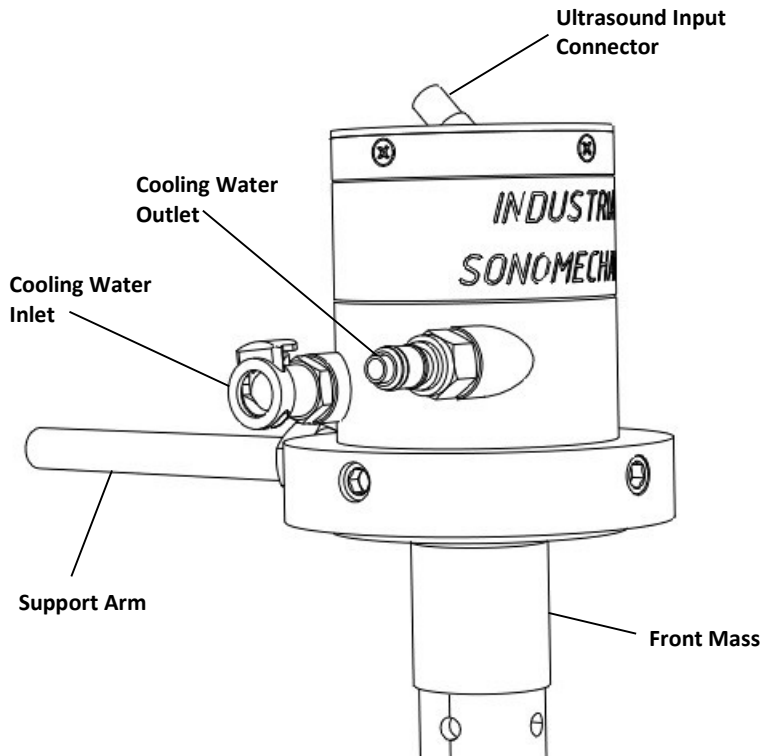

Figure 10. SWCT-1200 ultrasonic transducer.

CAUTION



Operating the SWCT-1200 transducer without cooling water may cause irreversible damage and is strictly prohibited.

CAUTION



The ultrasound cable assembly should not be used to carry the transducer or pull it toward the user. Make certain the cable always has slack and is never tensioned. If necessary, move the generator or transducer closer to one another to accomplish this. If this is not possible, contact your ISM client representative to obtain a longer cable.

When properly cooled (see Caution box below), the SWCT-1200 ultrasonic transducer (see Figure 10) can operate continuously at frequencies around 20 kHz. This device is compatible with all ISM ultrasonic horns with tip diameters of 35 mm or less. SWCT-1200 is sealed to the outside environment, which makes it suitable for high-humidity conditions and processing flammable materials, such as fuels and organic solvents.

CAUTION



The SWCT-1200 transducer must be cooled with water. The water flow rate must be at least 5 L/min and its temperature must be below 15 °C/59 °F (8 – 10 °C/46 – 50 °F is recommended). Operating the unit without the cooling water may cause irreversible damage and is strictly prohibited.

In no event can the transducer's front mass (area just above where the transducer meets the horn) be allowed to exceed 54 °C (129 °F).

WARNING



Do not remove any labels or stickers from the transducer or open the transducer housing lid. This may allow water to enter the internal area of the transducer and cause an electrical short.

Cooling Water Inlet & Outlet

During operation, it is imperative to cool the transducer with flowing water, supplied through the Cooling Water Inlet and removed via the Cooling Water Outlet (see Figure 10). The water flow rate must be at least 5 L/min and its temperature must be below 15 °C/59 °F (8 – 10 °C/46 – 50 °F is recommended). Alternative liquids are not recommended for cooling the transducer.

WARNING



Make sure to always connect the ultrasound cable to both the transducer and generator. Do not activate ultrasound if the cable is not connected to both devices.

Support Arm

The Support Arm is screwed into the transducer’s chassis and used for positioning the transducer in a clamp holder on a support structure.

Ultrasound Input Connector

The Ultrasound Input Connector is a high-voltage SHV-BNC connector, which meets the demands for heavy duty & heavy power applications under rugged environmental conditions. It provides superior shielding of electrical noise and mates with a corresponding connector on a fully shielded coaxial ultrasound cable that on the other side is attached to the SHV-BNC-type Ultrasound Output Connector at the generator (F in Figure 5).

Ultrasonic Horn

Liquids exposed to high-intensity ultrasound undergo ultrasonic cavitation, which produces violently and asymmetrically imploding bubbles and causes micro-jets that create extreme mechanical shear forces. These forces are responsible for the well-known ability of ultrasound to facilitate many physical and chemical processes. In order to produce sufficient cavitation intensity while retaining large ultrasound-emitting surfaces, ultrasonic transducer is equipped with a high-gain Barbell Horn®, which amplifies the vibration amplitude generated by the transducer and delivers the ultrasonic energy to the processed liquid.

The BSP-1200 ultrasonic processor is typically supplied with a high-gain HBHB-type ultrasonic Barbell Horn® (F in Figure 11). Other Barbell Horn® options compatible with the BSP-1200 are displayed in Figure 11.

CAUTION



Do not allow any vibrating surface of a horn or transducer to come in direct contact with any solid object (e.g., batch container, support clamp, reactor chamber) during system operation.

NOTE

Record each ultrasonic horn’s frequency and power when operating in free air and in water (Appendix III). This provides reference information throughout the life cycle of each horn.

CAUTION



NEVER clamp the horn in a vise. The resulting scratches or gouges on the surface are stress risers, which may result in horn cracks and failure.

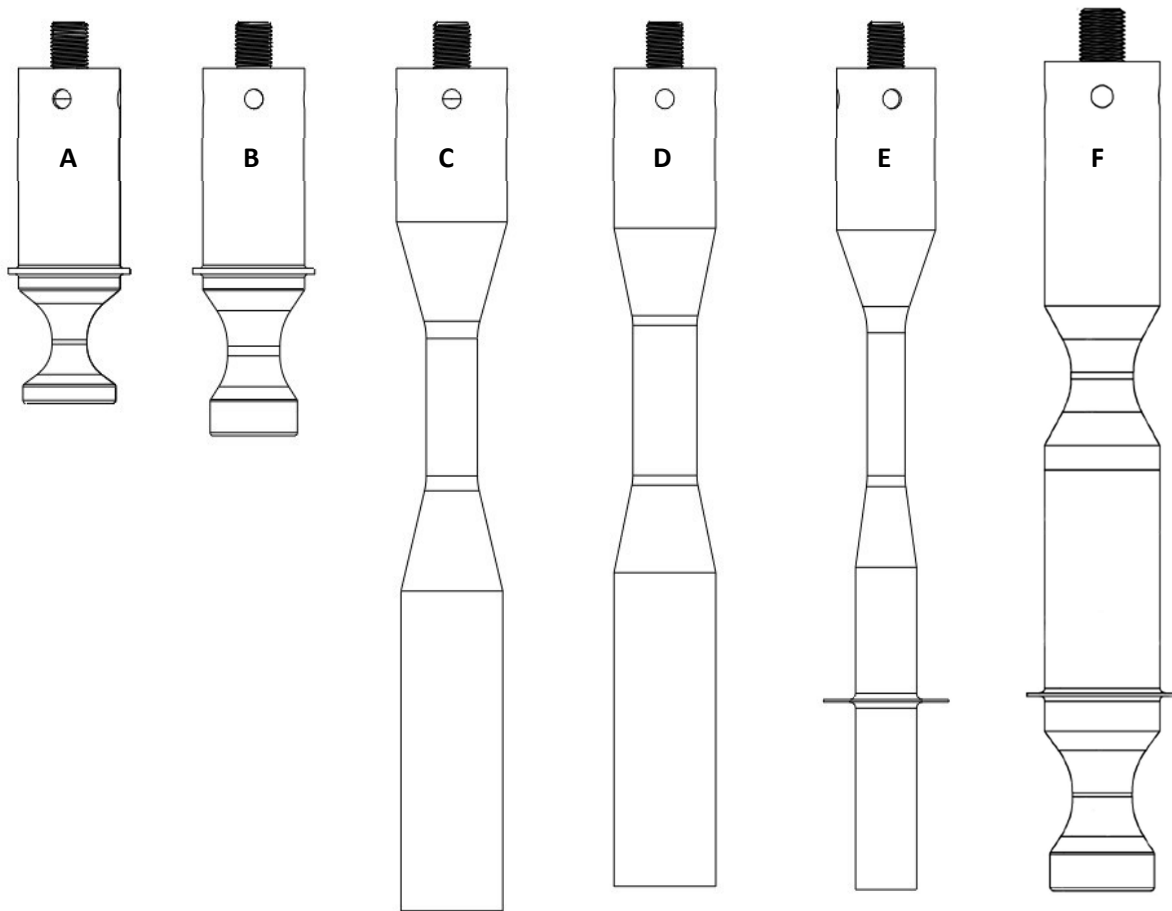

Figure 11. Barbell Horns® compatible with the BSP-1200 ultrasonic processor. A – HBH-F20D32G4s; B – HBH-F20D30G2.6s; C – FBH-F20D35G3.8s; D – FBH-F20D35G2.1s; E – FBH-F20D21G5s; F – HBHB-F20D30G4s.

ID	Batch or Flow-Through	Maximum Amplitude [μm]	Volume Processing Capacity	Process Liquid Viscosity Allowance	Notes
A	Flow-Through	95	1000 mL – Unlimited	≤ 100 cP	This horn is utilized for flow-through applications involving low-viscosity liquids.
B	Flow-Through	63	1000 mL – Unlimited	≤ 1000 cP	This horn is utilized for flow-through applications of medium/high-viscosity liquids.
C	Batch	97	500 – 2000 mL	≤ 100 cP	This horn is utilized for batch processing of low-viscosity liquids.
D	Batch	57	500 – 2000 mL	≤ 1000 cP	This horn is utilized for batch processing of medium/high-viscosity liquids.
E	Flow-Through and Batch	115	100 mL – Unlimited	≤ 1000 cP	This horn is utilized for flow-through and batch applications involving elevated pressure or high-viscosity liquids.
F	Flow-Through and Batch	95	500 mL – Unlimited	≤ 100 cP	This horn is utilized for flow-through and batch applications involving low-viscosity liquids.

Table 4. Description of Barbell Horns® compatible with BSP-1200 ultrasonic processor.

Attaching the Horn to the Transducer

1. Inspect all surfaces to be joined for stress cracks, chips, or gouges. Any of these irregularities will affect operation and could lead to further equipment damage.
2. Ensure that the mating surfaces of the two components are clean and smooth (can be cleaned with ethanol or isopropyl alcohol). These surfaces must make intimate contact for the mechanical energy to pass from one component to the next. Pitting or a buildup of dirt on a mating surface will interfere with the energy transfer and reduce the delivered power.
3. Remove any foreign matter from the horn's threaded stud and transducer's mating hole.
4. (For flow-through mode only) Place the reactor chamber lid over the top of the HBHB-type Barbell Horn®.
5. Place the provided mylar acoustic washer over the horn's stud against the horn's mating surface before assembling the components.
6. Thread the components together by hand and then tighten using the supplied spanner wrenches. See Figure 12 for the correct tightening procedure.
7. After attaching a horn, perform the *Scan Stack Procedure* described in Appendix I and then benchmark the ultrasonic stack (Appendix III).

CAUTION



Never leave a horn/transducer assembly hand-tight. Torque it to the proper specifications before proceeding. If the assembly is installed without being properly torqued down, the assembly may vibrate severely, damaging the mating surfaces and causing the generator to overload. Always use the mylar washer (one) during this procedure, otherwise mating surfaces may permanently bond. Make sure the washer is in good condition, without scratches or rips. Using a damaged washer may cause the assembly to operate incorrectly.

CAUTION



Do not substitute the provided spanner wrenches with any other tools. NEVER rely on the transducer's support arm instead of the provided spanner wrench during the horn attachment or detachment procedure as it may permanently damage the transducer.

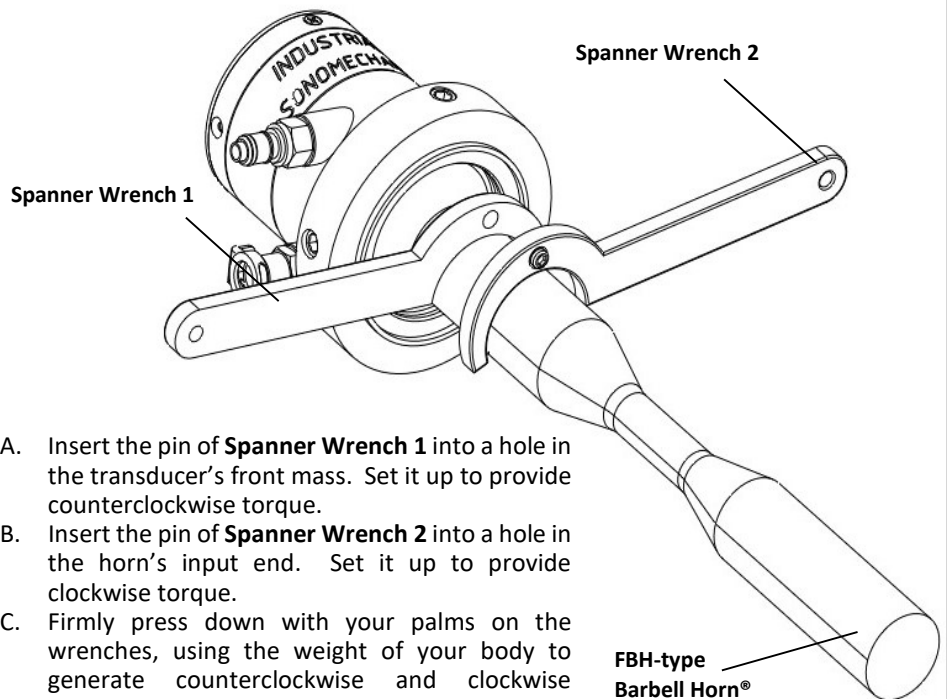

- A. Insert the pin of **Spanner Wrench 1** into a hole in the transducer's front mass. Set it up to provide counterclockwise torque.
- B. Insert the pin of **Spanner Wrench 2** into a hole in the horn's input end. Set it up to provide clockwise torque.
- C. Firmly press down with your palms on the wrenches, using the weight of your body to generate counterclockwise and clockwise torques on **Spanner Wrenches 1 and 2**, respectively.

***Note that the same procedure applies to all Barbell Horn® types.**

Figure 12. Attaching a Barbell Horn® to the SWCT-1200 transducer.

Detaching the Horn from the Transducer

On all transducers and horns with spanner wrench holes, use only the correct size spanner wrenches to provide sufficient torque to loosen a joint (see Figure 13).

CAUTION



Do not substitute the provided spanner wrenches with any other tools. Never rely on the transducer's support arm instead of the provided spanner wrench during the horn attachment or detachment procedure as it may permanently damage the transducer.

CAUTION



The transducer support arm and the reactor chamber should be removed before detaching the horn from the transducer.

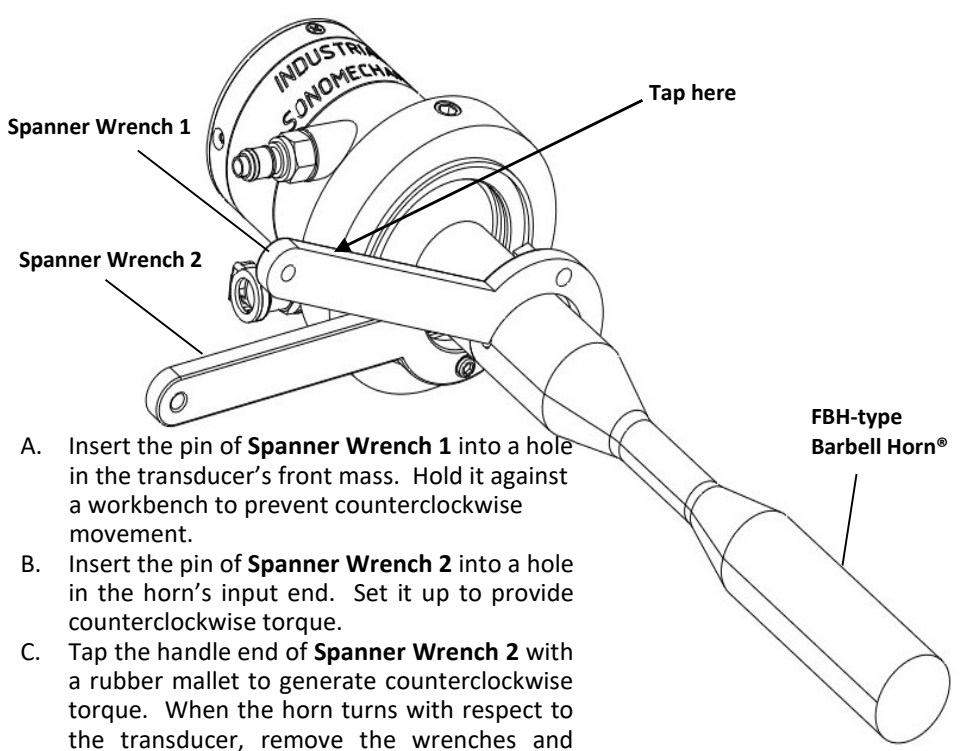

Spanner Wrench 1

Spanner Wrench 2

Tap here

FBH-type Barbell Horn®

- Insert the pin of **Spanner Wrench 1** into a hole in the transducer's front mass. Hold it against a workbench to prevent counterclockwise movement.
- Insert the pin of **Spanner Wrench 2** into a hole in the horn's input end. Set it up to provide counterclockwise torque.
- Tap the handle end of **Spanner Wrench 2** with a rubber mallet to generate counterclockwise torque. When the horn turns with respect to the transducer, remove the wrenches and continue to unthread the horn by hand.

***Note that the same procedure applies to all Barbell Horn® types.**

Figure 13. Removing a Barbell Horn® from the SWCT-1200 transducer.

CAUTION



Any unusually loud noise from the transducer/horn assembly indicates that it may have been assembled improperly. If the equipment produces a loud piercing or squealing sound, disassemble the horn from the transducer and repeat the horn attachment procedure following all instructions.

Reactor Chamber (RC-BSP-1200)

With the use of the reactor chamber (flow cell), the BSP-1200 ultrasonic processor can be configured for single-pass or recirculating (see Figure 2) liquid processing in the **flow-through mode**. When a large amount of material needs to be processed, this arrangement is preferable to the **batch mode** because it results in a much higher processing capacity, improved ultrasonic exposure uniformity and better temperature stability. In the **flow-through mode**, the use of the reactor chamber ensures that all processed liquid is directed through the active cavitation zones created by the incorporated **HBHB-Type Barbell Horn®**, resulting in homogeneous ultrasonic exposure and high product quality. The reactor chamber for the BSP-1200 includes a water-cooling jacket to help maintain the temperature of the processed liquid at a desired level.

Figure 14 shows the reactor chamber assembled with an **HBHB-Type Barbell Horn®**. The output diameter of the horn is commonly 30 mm, and the internal volume of the **Reactor Chamber – Process Side** is about 60 ml. The penetration of the horn into the chamber is arranged such that the non-vibrating mounting flange on the horn is "sandwiched" between the body of the reactor chamber and its lid through a split sanitary gasket, which ensures a reliable, pressure-resistant seal. The processed liquid is supplied through a ½" sanitary flanged **Processed Liquid Inlet** and collected through a ½" sanitary flanged **Processed liquid Outlet**. Cooling liquid (e.g., chilled water) is supplied through the female-type quick disconnect (**Coolant Inlet**) and collected through the male-type quick disconnect (**Coolant Outlet**).

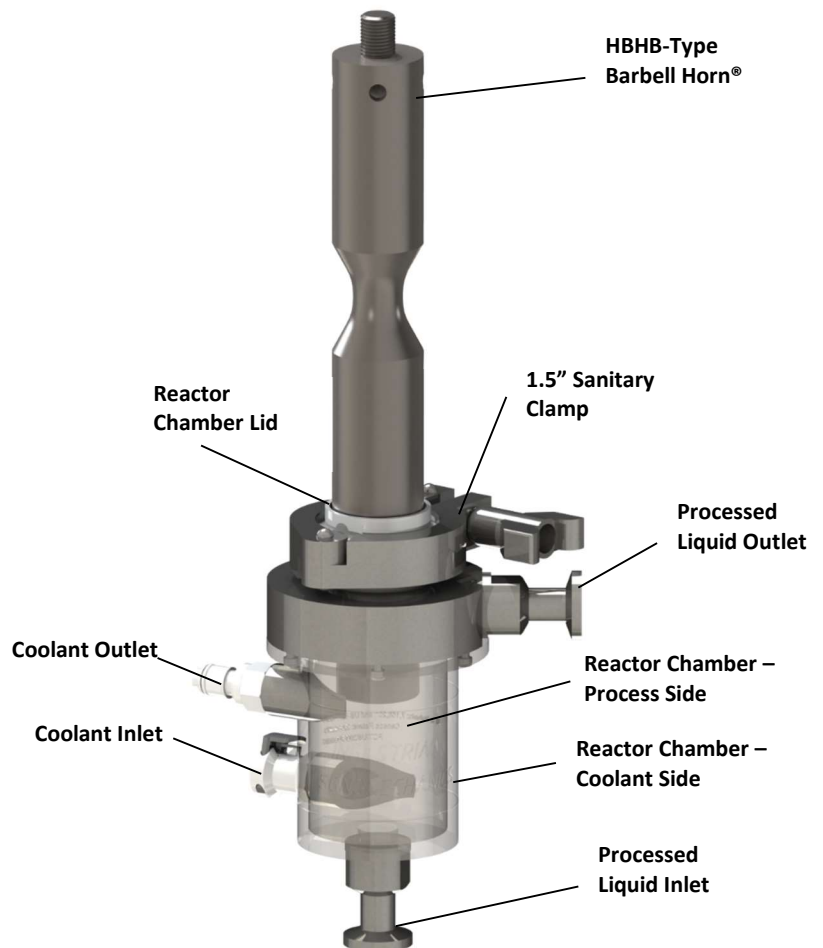
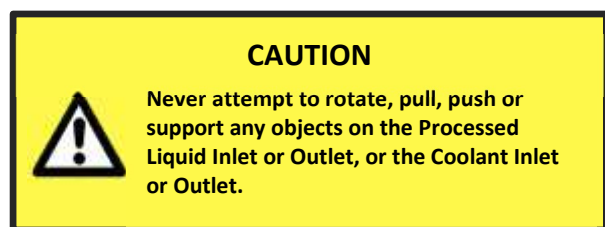

Figure 14. Reactor chamber for the BSP-1200 processor.



Assembling the Reactor Chamber with a Barbell Horn®

Follow the steps below to properly assemble the reactor chamber:

Step 1. (see Figure 15)

- a. Make sure that the **Split Sanitary Gasket** is evenly placed around the horn flange.
- b. Place the **Reactor Chamber Lid** over the horn from the horn's input end, so that its bottom is in contact with the **Split Sanitary Gasket**.

Step 2.

- a. Assemble the transducer with the horn as described in Figure 12. The procedure remains unchanged, even with a different Barbell Horn®.
- b. Secure the Transducer/Horn Assembly with its support arm on the support stand, (see figure 16a).

Step 3.

- a. Secure the **Reactor Chamber – Main Body** by its support arm in the clamp on the support stand below Transducer/Horn Assembly.
- b. Align the **Reactor Chamber – Main Body** such that when it is lifted, the horn can enter its internal area, (see Figure 16b).

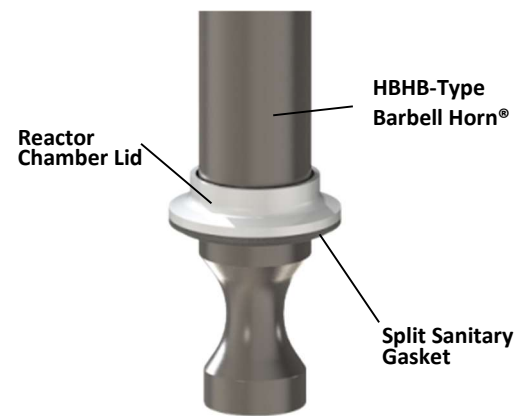

Figure 15. HBHB Horn with Split Sanitary Gasket and Reactor Chamber Lid

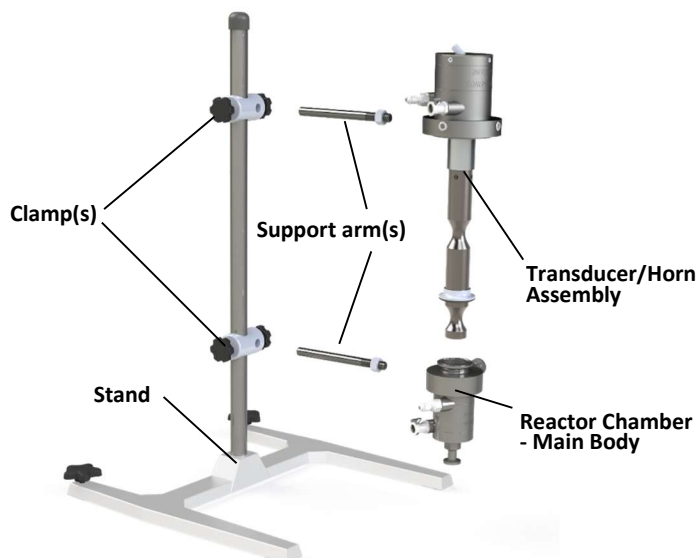
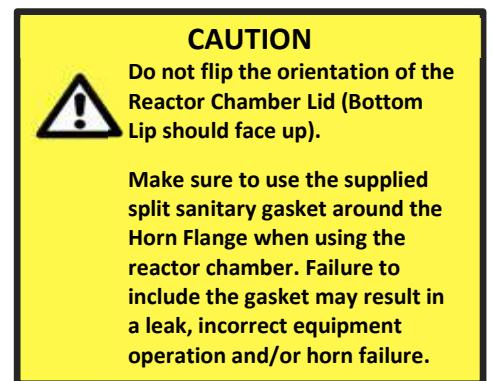

Figure 16a. Assembly of support arms of Transducer/Horn Assembly and Reactor Chamber



Figure 16b. Alignment of Transducer/Horn Assembly and Reactor Chamber

Step 4.

- a. Loosen the clamp securing the **Reactor Chamber – Main Body** support arm to the stand. Slide the **Reactor Chamber – Main Body** upward until the split sanitary gasket aligns and rests on the **Reactor Chamber – Sanitary Adapter**, (see Figure 17a).
- b. Tighten the clamp holding the **Reactor Chamber – Main Body** on the support stand.
- c. Place the **1.5” Sanitary Clamp** around the **Reactor Chamber Lid/Horn Flange** with and tighten by hand while verifying proper alignment. Do not use any tools for this operation as this may overtighten the assembly, (see Figure 17b).



Figure 17a. Reactor Chamber in place for final assembly step.



Figure 17b. Securing the assembly with 1.5” Sanitary Clamp.

CAUTION



A loud, piercing noise while attempting to initiate ultrasound, or abnormally high-power readings when ultrasound is activated may indicate that the reactor chamber was not assembled properly. Disassemble the reactor chamber (below) and repeat the assembly steps. Make sure to use the supplied sanitary gasket around the Horn Flange, the Reactor Chamber Lid – Bottom Lip faces up, and the 1.5” Sanitary Clamp is fastened properly (hand-tight).

Disassembling the Reactor Chamber from a Barbell Horn®

Follow the steps below to properly disassemble the reactor chamber (see Figure):

1. While the ultrasonic stack (transducer/horn/reactor chamber assembly) is still positioned on the support stand, remove the **1.5" Sanitary Clamp**.
2. Lower the **Reactor Chamber – Main Body** after loosening the clamp that secures the reactor chamber to the support stand.
3. Remove the **Reactor Chamber – Main Body** by pulling it forward after loosening the clamp that secures the reactor chamber's support arm.
4. If you are detaching the horn from the transducer, remove the ultrasonic stack (transducer/horn assembly) from the support stand by pulling it forward after loosening the clamp that secures the transducer's support arm. Then see the "Detaching the Horn from the Transducer" section on page 24.

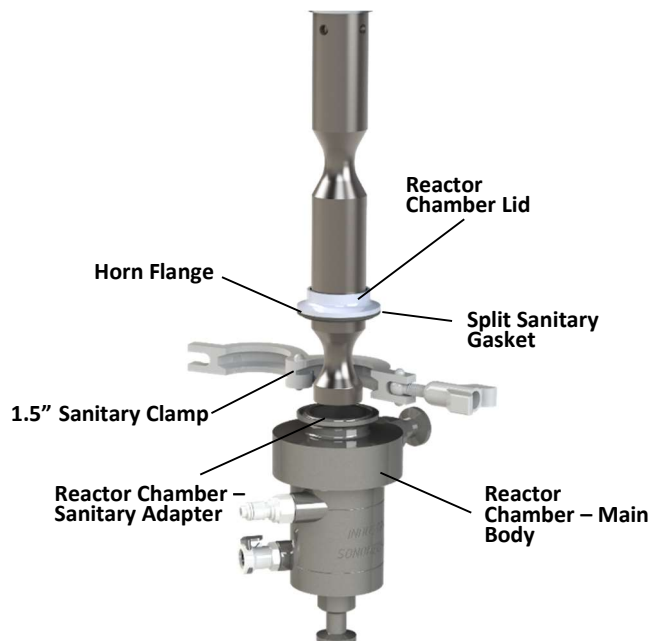

Figure 18. Reactor chamber disassembly procedure.

NOTE

The horn does not need to be detached from the transducer in order to remove the reactor chamber.

Operating and Batch-Mode Testing

Main Functions – ON, OFF, SCAN, AMP, TIME, START, STOP

1. Connect the power cord to the rear of the generator (**H** in Figure 5) and plug it into a grounded electrical outlet.
2. Flip the switch on the rear of the generator to the ON position (**G** in Figure 5). The screen will display the following by default:

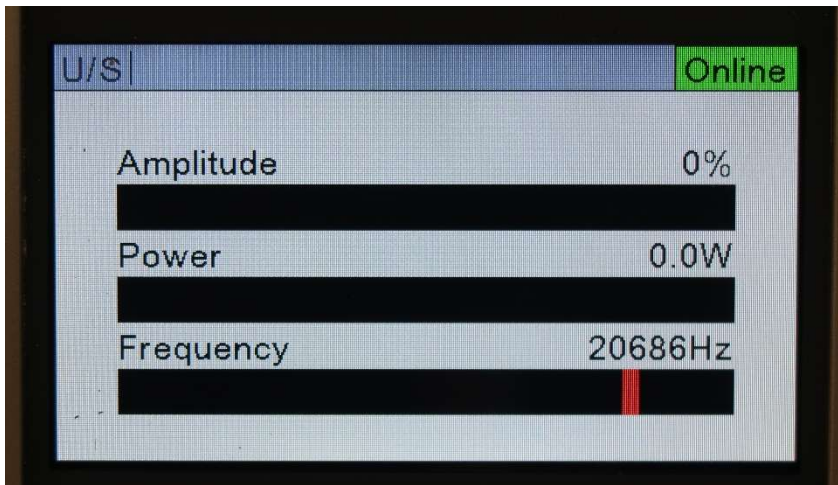

NOTE

The Frequency setting displayed by default on the generator screen will vary for different horns.

3. Before testing the ultrasonic unit, make sure that the tip of the horn it is not in contact with anything (in air).
4. Press the **START** key to initiate ultrasound; press the **STOP** key to stop ultrasound.
5. To set the duration of ultrasonic exposure, press **MENU/CANCEL**, use the **+ / -** to navigate to **Current Setup**, press **ENTER** and then navigate to **Run Mode**.
 - a. **Continuous** mode (default) will allow ultrasound to remain active once it is initiated (by pressing the **START** key). In this mode, ultrasound will only stop if the **STOP** key is pressed or if a process alarm is activated:

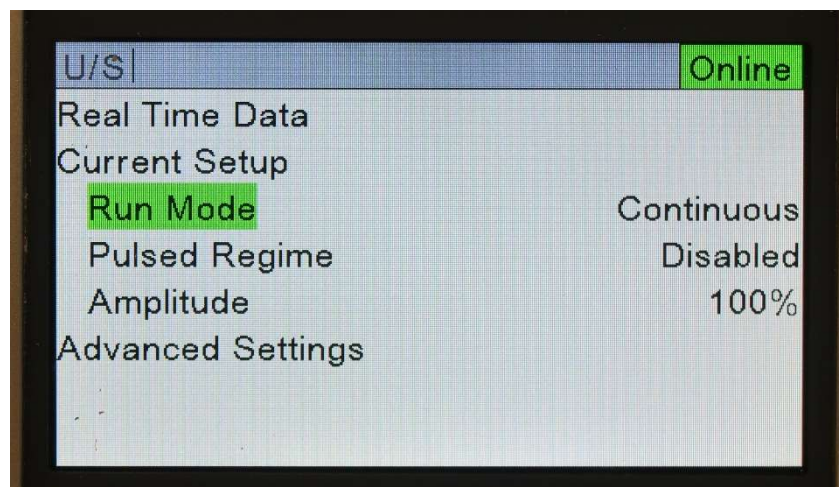

- b. Press **ENTER** if you would like to switch to **Timed** mode. **Duration** will appear and it will become possible to navigate to the timer (hr:min:sec) and use the **+/-**, **</>** and **ENTER** keys to set the desired ultrasonic exposure time. In **Timed** mode, ultrasound will initiate when the **START** key is pressed and will stop once the **Duration** time has elapsed (unless the **STOP** key is pressed or a process alarm is activated before the time elapses):

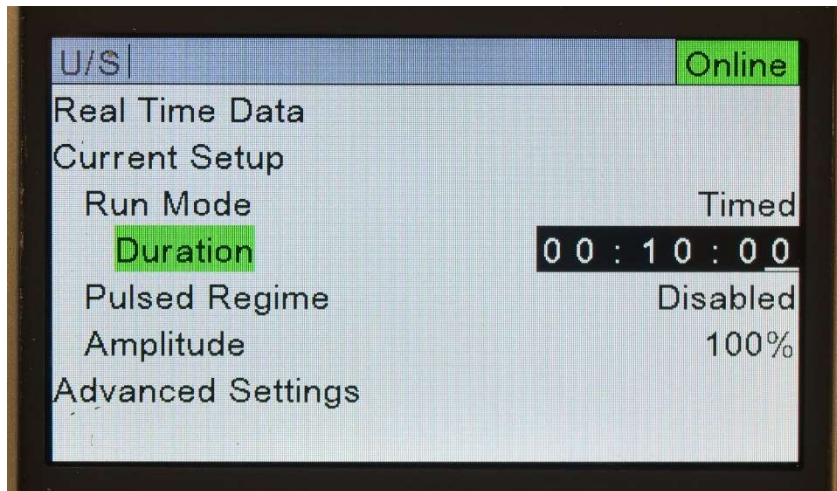

6. (FOR ADVANCED USERS) When **Enabled**, **Pulsed Regime** allows the operator to implement a duty cycle in their process. This means that the user can choose a certain amount of **On Time** and **Off Time** throughout the duration of ultrasonic exposure. **Pulsed Regime** should only be **Enabled** in **Timed** mode. Note that when **Pulsed Regime** is **Enabled**, after the operator presses **START**, the amount of time set for **Duration** will only accrue during the **On Time** of the duty cycle. For example, in the setup show below, the timer begins when the operator presses **START** and will run for 10 seconds while ultrasonic exposure is active; after 10 seconds, the ultrasonic exposure and the timer will stop for 10 seconds and will then start again. This duty cycle will repeat until 10 minutes of **On Time** have elapsed:



7. To adjust the amplitude, press **AMP**, then use the **+/-**, **</>** and **ENTER** keys to change and set the amplitude:

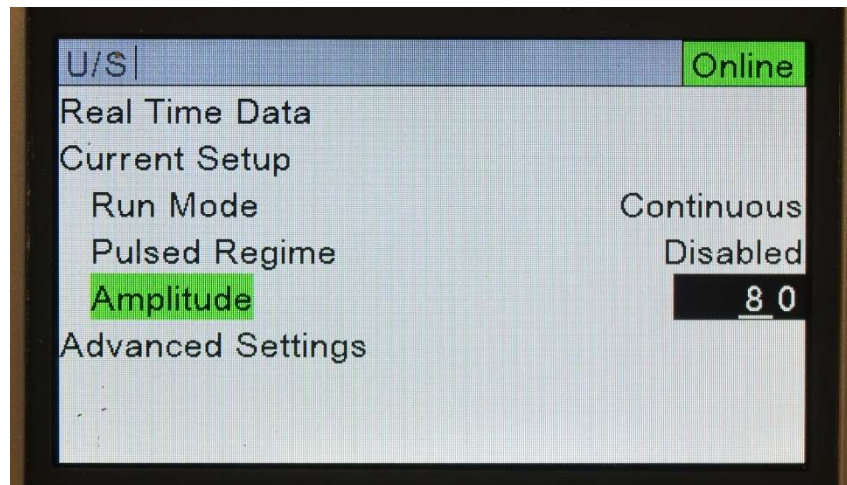

8. It is also possible to initiate ultrasound by pressing and holding the **TEST** button.
9. Release the **TEST** button to stop ultrasound.

Testing

Use the following steps to make sure your BSP-1200 processor is running according to specifications. These tests should be performed with the Barbell Horn® immersed in water at the temperature of approximately 25 °C (77 °F).

System Test in Water (Batch Mode Configuration)

1. Assemble your BSP-1200 processor in the batch-mode configuration (see Figure 1).
2. Connect the cooling lines to the SWCT-1200 transducer's cooling jacket so that it can be cooled to specification (see System Overview – Transducer section).
3. Fill a 1 L beaker $\frac{3}{4}$ full with water and place it under the ultrasonic stack.
4. Insert the HBHB or FBH-type Barbell Horn® into the water by about 6 cm and make sure that there is at least 5 cm of distance from the tip of the horn to the bottom of the beaker (see Figure 19).

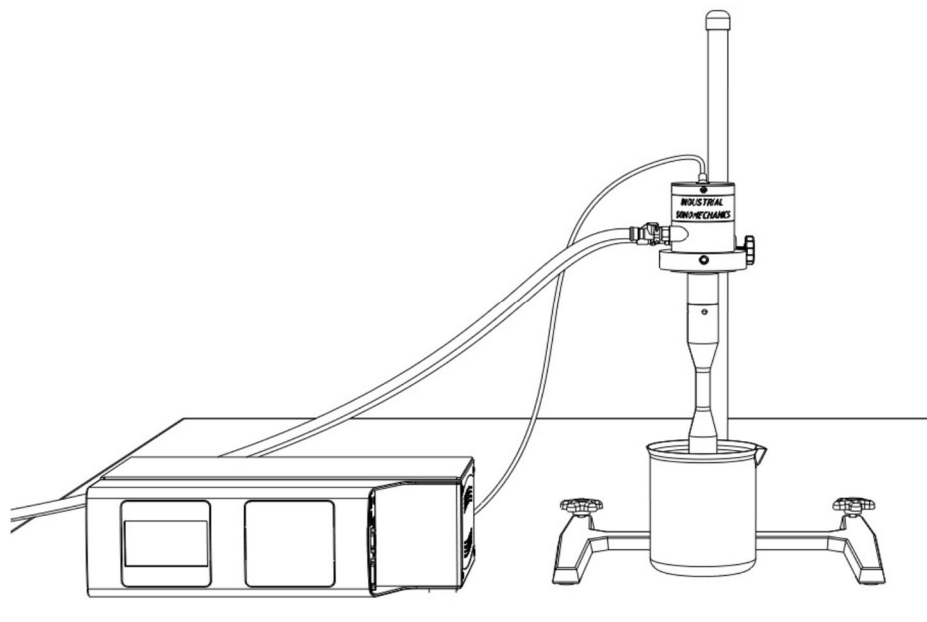
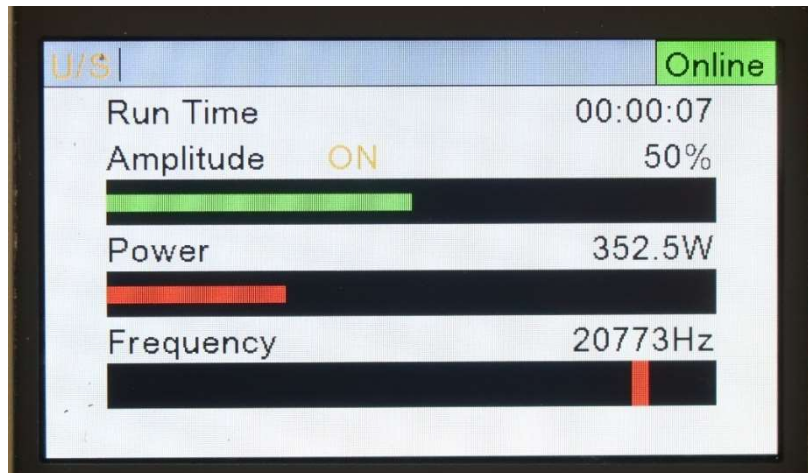

Figure 19. Batch-mode setup for processor test in water. Refer to Figure 1 for part names.

5. Set the amplitude to 50 % and place noise canceling earmuffs over your ears.

6. Press the **START** button to initiate ultrasound. You should hear a loud hiss and notice cavitation in the liquid. The generator power display should show approximately 300 - 500 W, and the temperature of the water should begin to increase. Record the power and frequency corresponding to this ultrasonic stack operating at the 50 % amplitude setting in Appendix III.



7. After 1 – 2 minutes, press **STOP** to deactivate ultrasound.
8. Set the amplitude to 90 % and keep the noise canceling earmuffs over your ears.
9. Press the **START** button to initiate ultrasound. You should now hear a louder hiss and notice intense cavitation in the liquid. The generator power display should show approximately 600 – 900 W, and the water temperature should begin to increase faster. Record the power and frequency corresponding to this ultrasonic stack at the 90 % amplitude setting in Appendix III.

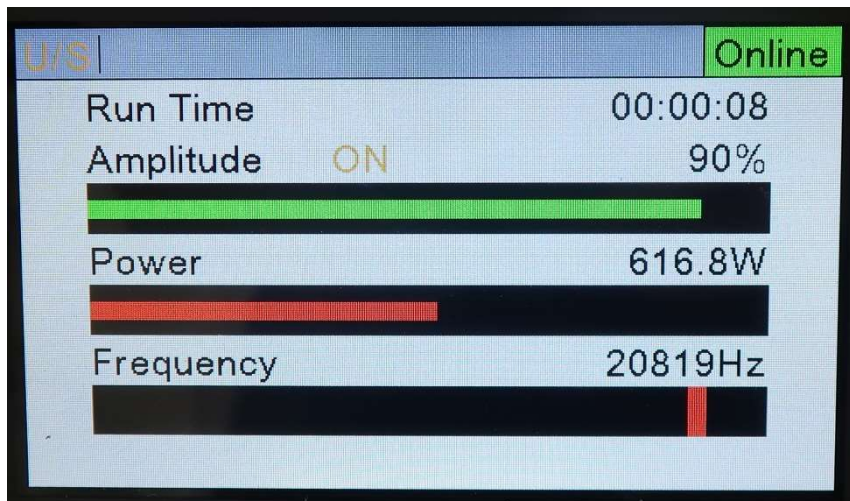

10. After 1 – 2 minutes, press **STOP** to deactivate ultrasound.

SECTION 5

Maintenance & Troubleshooting

General Maintenance

It is recommended to periodically inspect the unit to ensure optimum and safe performance. The inspection should be scheduled as a routine maintenance procedure, performed with the unit unplugged from the AC power source.

Check the generator, transducer, and all cables periodically for signs of contamination. If found, move the ultrasonic processor away from the source of the contaminant.

Examine the condition of the ultrasound cable. Inspect the wire insulation for damage, such as wear, burning or breakage from extended use or rough handling. The cable assembly should not be used to carry the transducer or pull it toward the user. Make certain the cable always has slack and is never tensioned. If necessary, move the generator or transducer closer to one another to accomplish this. If this is not possible, contact your ISM client representative to obtain a longer cable.

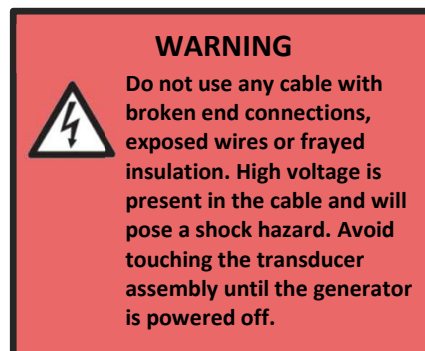

Horn Maintenance

Ultrasonic processors create high-amplitude vibration which puts stress on the transducer and horns. The sides and tip of a vibrating horn must **never** be allowed to come in contact with any solid object. Attempting to place a vibrating horn directly onto a solid surface will cause severe damage to the horn and/or transducer.

Proper horn care is essential for dependable operation. Cavitation will, however, cause the tip to erode over time. It is recommended that a preventative maintenance schedule be adopted to examine the unit at regular intervals. Horns should be benchmarked for power and frequency (Appendix III) during every scheduled maintenance check.

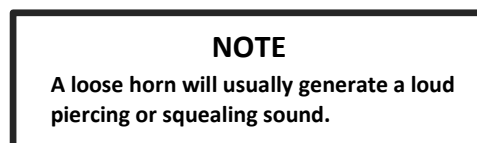

System Cleaning Instructions

Generator and Transducer

The generator and transducer may be cleaned with an acid-free cleaning solution (e.g., glass cleaner).

Horns and Reactor Chamber

Horns and reactor chamber can be cleaned using water with dish soap or isopropyl alcohol. Additionally, before and after using a horn in an experiment, be sure to briefly (< 30 sec) run it in clean water to remove any remaining residue.

Troubleshooting

Your Ultrasonic Processor was designed to provide you with years of safe and dependable service. Nevertheless, because of component failure or improper usage, the possibility does exist that it might not perform as it should, shut down or stop working. In the event that you experience an error, before troubleshooting, verify the following items:

1. Ensure that all cables/adapters are properly connected to the generator, including:
 - a. Power cable connected to the generator's AC power entry (**H** in Figure 5) at one end and to a grounded and properly rated outlet at the other;
 - b. Ultrasound cable connected to the rear of the generator (**F** in Figure 5) at one end and to the transducer at the other;
 - c. SYSTEM I/O adapter (**E** in Figure 4).
2. The electrical outlet that the generator is plugged into is properly rated (see Section 6).

CAUTION



Do not make multiple repeated attempts to start the generator after a Process Alarm error is reported without finding the cause of the problem.

Do not defeat the generator's overload protection by attempting to activate the ultrasonic output at a low amplitude setting (20 – 50 %) when an overload error was repeatedly reported at a higher setting.

NOTE

If a Process Alarm is reported by the generator, press **ENTER** to clear the Process Alarm. Afterwards, ultrasound can be restarted.

The standard process alarm message template is displayed in Figure . Table , below provides information for each Alarm ID #.

Process Alarm

Alarm ID # U308

Not Ready

Figure 20. Process alarm display.

Faults Errors	
U100	Configuration Fault. The default setup may be corrupted, the model number does not match the generator's installed assemblies, the Serial Number is incorrect or missing.
U104	Frequency Overload Fault 1. The generator was unable to find the stack's frequency by twice the time of the Ramp Up setting.
U106	Peak Overload Fault. The generator's output current has exceeded its safe operating level and has terminated the ultrasound output.
U108	Average Overload Fault. The output power has exceeded the rated power of the generator model.
U110	Power not OK Fault. There is a problem with the AC line voltage.
U111	Over Temperature Fault. Generator has exceeded its safe operating temperature limit.
U112	Frequency Overload Fault 3. There was excessive operating frequency drift due to heating of the stack. The operating frequency is "far" away from the Free Running Frequency.
U116	Ultrasound Voltage Overload. The actual transducer voltage exceeded the maximum expected value at 100 % amplitude.
Initiate Errors	
U302	Ultrasound Activation Input Activated at End of Cycle.
U308	Generator Not Ready. The generator initialization process is not complete. The generator is not ready to activate the ultrasound output. The Automation Cycle Stop input is activated while activating the Ultrasound Activation input.
Process Errors	
U401	Time Set to Zero
U402	Power Set to Zero

Table 5. Process Alarm Codes.

If you repeatedly experience any of the Process Alarms described in Table 5, perform the following troubleshooting steps:

Step 1 Make sure the horn and the transducer are properly assembled (see page 23). Confirm that there is **ONE** mylar acoustic washer between the horn and transducer and that the assembly has been properly tightened with the provided spanner wrenches. In this section we will refer to the Transducer/Horn Assembly as "ultrasonic stack".

- a. If you are in the flow-through mode, make sure that the reactor chamber is assembled properly (see page 26). Confirm that the split ID gasket is set evenly around the horn flange, the reactor chamber lid is oriented so that its extended lip faces up, the 1.5" sanitary clamp is properly attached and firmly tightened (by hand), and the reactor chamber is being supported with its provided support arm.

Step 2 If you continue to experience this error, try operating your system with the horn in free air.

- a. In the batch mode, lift your horn out of the liquid, set the amplitude to 80 % and attempt to initiate ultrasound. If the ultrasonic stack successfully starts **AND** the power displayed on the generator is within 40 W of the value indicated for your horn on the bottom of the *Scan Stack Protocol* (Appendix I) or the value you benchmarked (Appendix III) for your ultrasonic stack when you received it, then continue to Step 3. If a Process Alarm persists, then disassemble and reassemble the ultrasonic stack (see pages 23 and 24), perform the *Scan Stack Protocol* and attempt to initiate ultrasound again. If the fault persists, please contact ISM.
- b. In flow-through mode, drain all liquid out of your reactor chamber, set the amplitude to 80 % and attempt to initiate ultrasound with the empty chamber. If the ultrasonic stack successfully starts **AND** the power displayed on the generator is within 40 W of the value indicated for your

horn on the bottom of the *Scan Stack Protocol* (Appendix I) or the value you benchmarked (Appendix III) for your ultrasonic stack when you received it, then continue to Step 3. If a fault error persists, remove the reactor chamber from the ultrasonic stack assembly and then disassemble and reassemble the ultrasonic stack (see pages 23 and 24). Do not attach the reactor chamber. Perform the *Scan Stack Protocol* and attempt to initiate ultrasound again. If the ultrasonic stack successfully starts **AND** the power displayed on the generator at 80 % amplitude is within 40 W of the value indicated for your horn on the bottom of the *Scan Stack Protocol* (Appendix I) or the value you benchmarked (Appendix III) for your ultrasonic stack when you received it, then reassemble the reactor chamber and repeat Step 2b. If the fault persists, please contact ISM.

- Step 3** Once your ultrasonic stack properly operates in air, attempt to run it in pure warm (~25 °C) water.
- a. In batch mode, insert the horn, to its flange (by about 5 cm), into a beaker of water (at least 2 L) and attempt to initiate ultrasound. If the ultrasonic stack successfully starts **AND** the power displayed on the generator at 80 % amplitude is within 100 W of the value indicated for your horn on the bottom of the *Scan Stack Protocol* (Appendix I) or the value you benchmarked (Appendix III) for your ultrasonic stack when you received it, continue to Step 4. If a fault error persists or the power is out of the allowed range, please contact ISM.
 - b. In the flow-through mode, begin pumping water through the reactor chamber. Stop your pump so that there is stagnant water in your reactor chamber and attempt to initiate ultrasound. If the ultrasonic stack successfully starts **AND** the power displayed on the generator at 80 % amplitude is within 100 W of the value indicated for your horn on the bottom of the *Scan Stack Protocol* (Appendix I) or the value you benchmarked (Appendix III) for your ultrasonic stack when you received it, then turn the pump back on. If the unit then reports a fault error or the power displayed is above 1000 W, then your pumping rate is too high and must be reduced. If after reducing the pumping rate the power displayed is below 900 W then continue to Step 4. If the fault error persists in stagnant water, drain the chamber, remove the reactor chamber from the ultrasonic stack, disassemble and reassemble the ultrasonic stack (see pages 23 and 24). Do not attach the reactor chamber. Perform the *Scan Stack Protocol* and Step 3a. If successful, reassemble the reactor chamber and repeat Step 3b. If the fault persists, contact ISM.
- Step 4** Once your ultrasonic stack is properly operating in water, perform similar tests with your processed liquid. If the error persists, then there is likely some property of your processed liquid that is preventing cavitation (e.g., too viscous, completely degassed). Please contact ISM to request a call with a specialist to discuss/troubleshoot your application.

While it is unlikely, it is possible for your unit to be operating off specification, yet without triggering a process alarm. Some harmful occurrences with their possible causes and suggested solutions are provided below.

Occurrence	Probable Causes	Suggested Solutions
POWER JUMPS OR DRIFTS DURING OPERATION	<p>The power reading on the display of the generator should generally be stable within about +/- 100 W, unless the operating parameters change during processing. Predictable and normal power changes are relatively slow and can be due to the following:</p> <ul style="list-style-type: none"> • An increase in power due to an increase in pressure in the reactor chamber or a deeper insertion of the horn into the processed liquid. • An increase in power due to an increase in viscosity of the processed liquid or to the degassing of the processed liquid. • A decrease in power due to an increase in temperature or a decrease in viscosity of the processed liquid. • A decrease in power due to foam generation in the processed liquid. 	
EQUIPMENT MALFUNCTIONS; LEAKS OR CABLE FRAYING OBSERVED	<ul style="list-style-type: none"> • Manufacturer’s error • Careless treatment of equipment • Electric short 	<p>Contact ISM</p>
RAPID HEATING OF THE TRANSDUCER AT THE HORN JUNCTION**	<p>Ultrasonic stack has been assembled improperly or has been damaged.</p>	<p>Disassemble and reassemble your ultrasonic stack (see pages 23 and 24). Make sure that there is a Mylar washer (one) between the horn and transducer and that they have been properly coupled with the provided spanner wrenches. If the error persists, contact ISM.</p>

**Due to the high-frequency vibrations present during sonication, the transducer/horn junction may feel hot (and likely painful) to touch when ultrasound is on. This may be mistaken for “overheating”. To correctly judge whether the junction is overheating, initiate ultrasound for 15 seconds, stop the ultrasonic output, and only then feel the junction.

SECTION 6

Specifications

Generator Specifications

Drawings

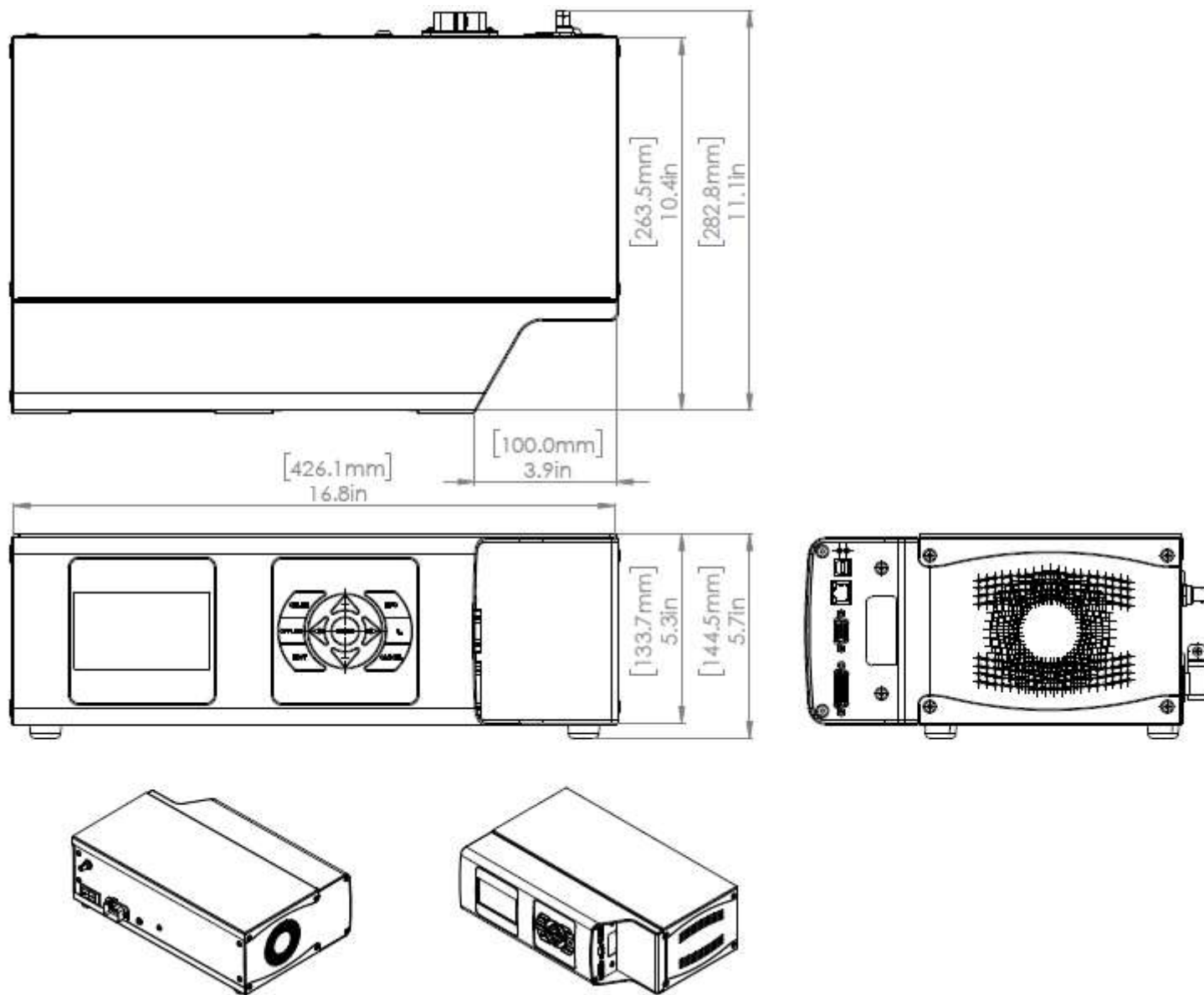

Generator Weight

25.4 lbs/11.5 kg

AC Power Requirements

100 - 240 V 50/60 Hz @ 15 Amps
North American/Japan AC Outlet Rating: 15 Amps
Output Voltage (Max): 1,300 VAC (Nominal)
Output Current (Max): 3 Amps (Nominal)

Regulatory Agency Compliance

FCC

The **generator** complies with the following Federal Communications Commission regulations:

- The limits for FCC measurement procedure MP-5, “Methods of Measurement of Radio Noise Emissions from Industrial Scientific or Medical Equipment”, pursuant to FCC Title 47 Part 18 for Ultrasonic Equipment.

CE (European Conformity) Marking

This mark on your equipment certifies that it meets the requirements of the EU (European Union) concerning interference causing equipment regulations. The **generator** complies with the following CE requirements:

- The EMC Directive 2004/108/EC for Heavy Industrial Environment:
 - EN 61000-6-4:2001, EN 55011:2003, EN 61000-6-2:2005, EN 61000-4-2, EN 61000-4-3, EN 61000-4-4, EN 61000-4-5, EN 61000-4-6 EN 61000-4-8, EN 61000-4-11
- The Low Voltage Directive 2006/95/EC
- The Machinery Directive 2006/42/EC
 - EN 60204:2006
 - Safety of Machinery – Electrical Equipment of Machines Part 1: General Requirements

IP Rating

The **generator** has an IP (International Protection) rating from the IEC (International Electrotechnical Commission). The rating is IP2X, in compliance with finger-safe industry standards.

UL & CSA

The **generator** complies with these standards:

- Underwriters Laboratories (UL): UL61010-1
- National Standards of Canada (CSA): CAN/CSA C22.2 No. 61010-12 as verified by TÜV Rheinland.



Safe Working Conditions	
Operating Environment	Temperature: 40 – 100 °F (5 – 38 °C) Air Particulates: Keep the equipment dry. Minimize exposure to moisture, dust, dirt, smoke and mold. Relative Humidity: 5 – 95 % (Non-Condensing @ 5 – 30 °C)
Shipping/Storage Environment	Temperature: -4 – 158 °F (-20 – 70 °C) Air Particulates: Keep the equipment dry. Minimize exposure to moisture, dust, dirt, smoke and mold. Relative Humidity 5 – 95 % (Non-Condensing @ 0 – 30 °C)
Other	For indoor use only

Specifications for Ultrasonic Stack and Peripheral Components

Stack Component	Description	Specification
SWCT-1200 transducer	Lower cooling port (Coolant Inlet) of the SWCT-1200 cooling jacket	Female-type Quick-Disconnect Coupling, ¼" Coupling Size to ¼" NPT Male-type Thread
	Upper cooling port (Coolant Outlet) of the SWCT-1200 cooling jacket	Male-type Quick-Disconnect Coupling, ¼" Coupling Size to ¼" NPT Male-type Thread
	Threaded holes for the Coolant Inlet and Coolant Outlet adapters	¼" NPT Female-type Thread
RC-BSP-1200 reactor chamber	Lower cooling port (Coolant Inlet) of the RC-BSP-1200 cooling jacket	Female-type Quick-Disconnect Coupling, ¼" Coupling Size to ¼" NPT Male-type Thread
	Upper cooling port (Coolant Outlet) of the RC-BSP-1200 cooling jacket	Male-type Quick-Disconnect Coupling, ¼" Coupling Size to ¼" NPT Male-type Thread
	Threaded holes for the Coolant Inlet and Coolant Outlet Adapters	¼" NPT Female-type Thread
	Stainless Steel adapter to connect to the Processed Liquid Inlet and Outlet of the RC-BSP-1200	½" Tri Clover to ½" Hose Barb
SWCT-1200/RC-BSP-1200	Adapters used to connect to the Coolant Inlet of the SWCT-1200 and RC-BSP-1200 cooling jackets	Male-type Quick-Disconnect Coupling, ¼" Coupling Size to 3/8" Hose Barbed ID
SWCT-1200/RC-BSP-1200	Adapters used to connect to the Coolant Outlet of the SWCT-1200 and RC-BSP-1200 cooling jackets	Female-type Quick-Disconnect Coupling, ¼" Coupling Size to 3/8" Hose Barbed ID
PP-BSP-1200	Silicone tubing that comes with the peristaltic pump	3/8" ID
CHLLR-1400-120	Silicone tubing that comes with the chiller	3/8" ID

SECTION 7

APPENDIX

I. Scan Stack Procedure

Each time you intend to use a new ultrasonic horn, you must determine and set its *Free Run Frequency* (FRF) and check its power when operating at the amplitude setting of 80 % in free air. FRF is the initial guess the generator makes when finding the horn's resonant/optimal frequency during operation. FRF can be determined by using the SCAN feature accessible from the ultrasonic generator's front panel. Follow the instructions below to scan the horn:

1. Attach the new horn to the ultrasonic transducer using the provided spanner wrenches (see page 23) and connect the ultrasound cable from the generator to the top of the transducer.
2. On the generator's keypad press **MENU/CANCEL**, then use the **+/-** keys to navigate to **Advanced Settings** and press **ENTER**.
3. Navigate to **Frequency Control**, press **ENTER**, then navigate to **Wide** and press **ENTER**.
4. Press **SCAN**. A warning message will appear. Confirm that the transducer is properly connected to the generator and that the tip or sides of the horn are not in contact with anything.
5. Press **ENTER** and the *Scanning* screen will display for 5 seconds.
 - a. If the scan was successful, the following **Scan Result** screen will display the **Optimal Frequency**. Press **ENTER** to update the Free Run Frequency.

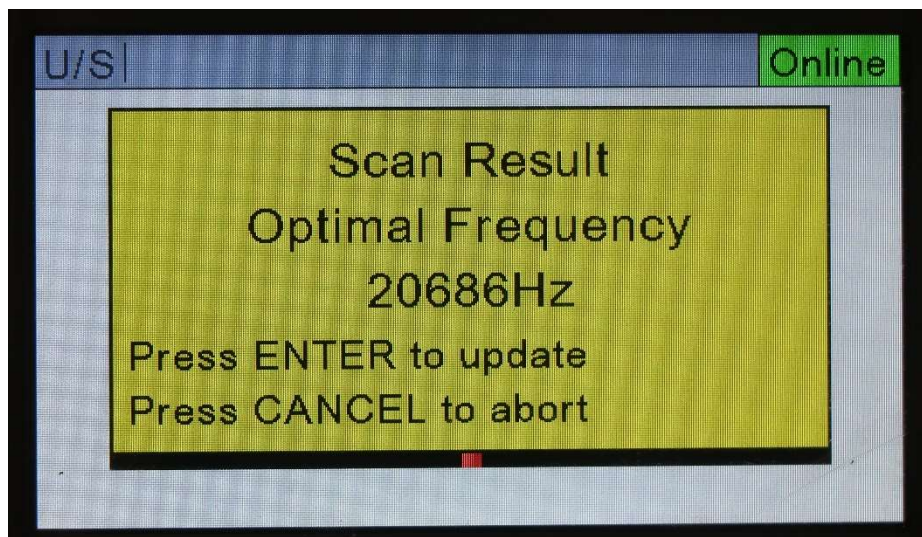

- b. If the scan failed, the following **Scan Result** screen will display the **Optimal Frequency not found**. Press **MENU/CANCEL** and begin this protocol from step 1, confirming that the horn and transducer are assembled properly and that each step is followed carefully. If the **SCAN** continues to fail, please contact ISM.

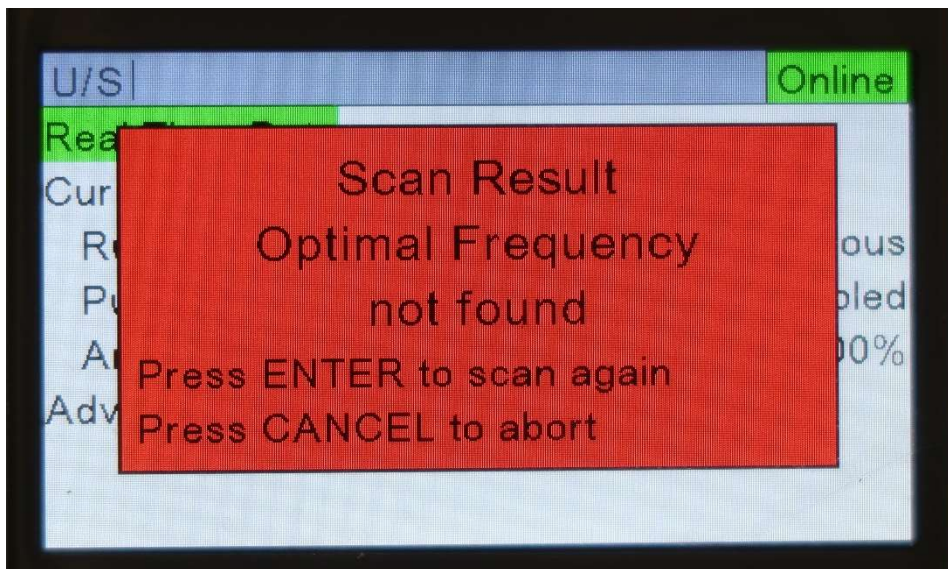

6. After a successful scan, repeat steps 2 and 3, but set the **Frequency Control** to **Normal**.
7. Set the amplitude to 80 % (see page 30). Confirm that the tip and sides of the horn are not in contact with anything.
8. Hold the **TEST** button and read the **Power** displayed on the generator screen. Use the table below and verify that your horn is operating at the proper power (within 40 W of the value tabulated below). If the power displayed is outside of this range, contact ISM.

Horn ID	Power (@80 %, in Air) [W] (+/- 40 W)
FBH-F20D35G2.1s	80
FBH-F20D35G3.8s	65
FBH-F20D21G5s	72
HBH-F20D30G2.6s	55
HBH-F20D32G4s	65
HBHB-F20D30G4s	80

II. Pin Layout and Descriptions for SYSTEM I/O Port (J5)

Pin 1 (+22 V)

This pin can supply +22 VDC at up to 500 mA to power the user's automation controls.

Pin 2 (Power Ground)

Pin 2 is the 22 VDC return and is tied to the system chassis ground.

Pin 3 (E-STOP Output)

Must be wired to Pin 4 for unit to operate.

Pin 4 (E-STOP Input)

Must be wired to Pin 4 for unit to operate.

Pin 5 (Remote Setup Selection Bit 0 Input)

Pin 5 is the Remote Setup Selection Bit 0, which is the least significant bit used to select different setups with an automation control system. This input is also used to select different channels when a Multi-Point Controller (MPC) module is connected to J2.

Pin 6 (Remote Setup Selection Bit 1 Input)

Pin 6 is the Remote Setup Selection Bit 1, which is the second least significant bit used to select different setups with an automation control system. This input is also used to select different channels when a MPC module is connected to J2.

Pin 7 (Remote Setup Selection Bit 2 Input)

Pin 7 is the Remote Setup Selection Bit 2, which is the third least significant bit used to select different setups with an automation control system. This input is also used to select different channels when a MPC module is connected to J2.

Pin 8 (Remote Setup Selection Bit 3 Input)

Pin 8 is the Remote Setup Selection Bit 3, which is the most significant bit used to select different setups with an automation control system. This input is also used to select different channels when a MPC module is connected to J2.

Pin 9 (Automation Cycle Stop Input)

Pin 9 is an input control signal that when enabled, can be used by the automation control system as a redundant signal to shut the ultrasound output off. This signal could also be reconfigured through menu selections to function as an automation end-of-process control signal input.

Pin 10 (Front Panel Lockout Input)

Pin 10 is used to lock the front panel user interface, so an operator cannot change any setups or configuration parameters that are stored in memory. This input has no effect on any of the supported industrial buses or iQ Commander. Deactivation of this signal allows normal operation, without any lockout restrictions.

Pin 11 (Isolated Input Common)

Pin 11 is electrically isolated from chassis ground. Using isolated sourcing (PNP) output drivers, this common line would be connected to isolated ground potential. Using isolated sinking (NPN) output drivers, this common line would be connected to the isolated positive supply voltage output. For correct operation of inputs, it is critical that this pin is connected to either isolated ground or positive supply.

Pin 12 (Ultrasound Activation/ Cycle Start Input)

Pin 12 is used to activate the generator ultrasound output. Activation of this control input will switch the ultrasound output ON, and deactivating this signal will switch ultrasound OFF. This input signal will also function as a cycle start input, where the ultrasound activation and timing are completely under the control of the process controller. Depending on the process controller setup, this input signal could be activated momentarily to start a cycle.

Pin 13 (Isolated Ultrasound Common)

Pin 13 is the common connection for Pin 12 (Ultrasound Activation/Cycle Start Input). Pin 13 is electrically isolated from chassis ground. Using isolated sourcing (PNP) output drivers, this common line would be connected to isolated ground potential. Using isolated sinking (NPN) output drivers, this common line would be connected to the isolated positive supply voltage output. For correct operation of the Ultrasound Activation/Cycle Start input it is critical that this pin is connected to either isolated ground or positive supply.

Pin 14 (Analog Input (0-10 VDC))**Pin 15 (Analog Input (0-10 VDC))****Pin 16 (Analog Ground)**

Pin 16 is the signal common (ground) connection for all of the analog signals (on Pins 14, 15, 17, and 18). This signal common pin is connected to system chassis ground and is not isolated from the generator chassis. This is an analog signal ground connection. Do not connect anything to this ground connection, except the wiring to the inputs/outputs of the analog devices.

Pin 17 (Analog Power Output (0-10 VDC))

Pin 17 is an analog output signal used to monitor the power output from the ultrasonic system. The scaling on this output signal is as shown below: 1 Watt = 0.001 VDC (1 mV per Watt)

Pin 18 (Analog Amplitude Output (0-10VDC))

Pin 18 is an analog output signal used to monitor the system amplitude setting. The scaling on this output signal is 100 % amplitude = 10.0 VDC, or 0.1 VDC per 1 % amplitude. Using this monitor output, the control system can verify that the amplitude is set to the expected programmed amplitude level.

Pin 19 (Ultrasound Status Output)

Pin 19 is a digital output that activates when the system is delivering ultrasonic power. This output will be an open circuit when the ultrasound output is off.

Pin 20 (Any Fault Status Output)

Pin 20 is a digital output that activates whenever any fault condition is detected that terminates/inhibits ultrasound output and normal system operation. This output will be an open circuit when no system fault conditions are detected. Any Fault output remains active until cleared by the System Latch Reset input or by the start of the next cycle. Generator faults that will activate the Any Fault output: Overload (Average, Peak, Frequency, Over Voltage), Over Temperature Fault, System Power Fault

Pin 21 (Overload Status Output)

Pin 21 is a digital output that activates whenever any overload condition is tripped. Activation of the overload status output signal could be caused by an Average, Peak, Frequency, or Over Voltage overload condition. After the overload status output activates, it will remain active until cleared by the System Latch Reset input or by the start of the next cycle. This output will be an open circuit when no overload conditions have been detected.

Pin 22 (Bad Part Status Output)

Pin 22 is a digital status output that activates, either momentarily or until the start of the next cycle, when the parameters recorded during the previous cycle are outside of the programmed bad part limits. This output will be an open circuit when a bad part has not been detected.

Pin 23 (Good Part Status Output)

Pin 23 is a digital status output that activates, either momentarily or until the start of the next cycle, when the parameters recorded during the previous cycle do not exceed the programmed suspect or bad part limits. This output will be an open circuit after a cycle when either a suspect or bad part has been detected.

Pin 24 (Ready Status Output)

This status output signal will activate only when the system is ready to activate ultrasound or begin a cycle. Pin 24 is a digital status output that activates when a processing cycle is completed and the process control system is ready to start the next cycle. This output will be an open circuit when the process controller determines that the next cycle cannot be started. This includes system faults or E-STOP active, but not a process fault like Overload.

Pin 25 (MPC Ready Status Output)

This status output signal will activate only when an MPC module is connected to the generator. Pin 25 is a digital status output that activates when the MPC controller is ready to start the next MPC cycle. This output will be an open circuit when the MPC system is not ready to start an MPC cycle. Any changes to the probe selection control bits will not be acted on until the completion of the current cycle. This status output signal will also be open (MPC NOT READY) if a fault

condition is detected inside the MPC module. If this status output will not activate, check for a red fault status indication, the SYSTEM STATUS LED, on the front of the MPC module.

Pin 26 (Isolated Output Common)

Pin 26 is electrically isolated from chassis ground. For isolated sourcing (PNP) inputs, this common line would be connected to isolated ground potential. Using isolated sinking (NPN) output drivers, this common line would be connected to the isolated positive supply voltage output.

Pin	Color	Description
J5-1	BLK/RED	+22 V CURRENT LIMITED POWER SUPPLY (500 mA MAX)
J5-2	RED/BLK	+22 V RETURN (iQ CHASSIS GROUND)
J5-3	BLK/WHT	E-STOP OUTPUT
J5-4	WHT/BLK	E-STOP INPUT
J5-5	BLK/GRN	REMOTE SETUP SELECTION BIT 0 INPUT
J5-6	GRN/BLK	REMOTE SETUP SELECTION BIT 1 INPUT
J5-7	BLK/BLU	REMOTE SETUP SELECTION BIT 2 INPUT
J5-8	BLU/BLK	REMOTE SETUP SELECTION BIT 3 INPUT
J5-9	BLK/YEL	AUTOMATION CYCLE STOP INPUT
J5-10	YEL/BLK	FRONT PANEL LOCKOUT INPUT
J5-11	BLK/BRN	ISOLATED INPUT COMMON
J5-12	BRN/BLK	ULTRASOUND ACTIVATION/CYCLE START INPUT
J5-13	BLK/ORN	ISOLATED ULTRASOUND COMMON
J5-14	ORN/BLK	ANALOG DISTANCE INPUT (0-10 VDC)
J5-15	RED/WHT	ANALOG AMPLITUDE INPUT (0-10 VDC)

J5-16	WHT/RED	ANALOG GROUND
J5-17	RED/GRN	ANALOG POWER OUTPUT (0-10 VDC)
J5-18	GRN/RED	ANALOG AMPLITUDE OUTPUT (0-10 VDC)
J5-19	RED/BLU	ULTRASOUND STATUS OUTPUT
J5-20	BLU/RED	ANY FAULT STATUS OUTPUT
J5-21	RED/YEL	OVERLOAD STATUS OUTPUT
J5-22	YEL/RED	BAD PART STATUS OUTPUT
J5-23	RED/BRN	GOOD PART STATUS OUTPUT
J5-24	BRN/RED	READY STATUS OUTPUT
J5-25	RED/ORN	MPC READY STATUS OUTPUT
J5-26	ORN/RED	ISOLATED OUTPUT COMMON

III. System to Specification Testing and Stack Benchmarking

It is recommended that you routinely benchmark your ultrasonic stack (transducer/horn assembly) to be able to ensure that system is operating to specifications. Record values for power and frequency corresponding to your ultrasonic stack in Table 6.

Test in air

1. Assemble the transducer and horn properly (see page 23) and secure the ultrasonic stack in the support stand (without the reactor chamber).
2. Plug the generator in a properly rated outlet and connect the ultrasound cable from the generator to the top of the transducer.
3. Set the amplitude on the generator to 80 % (see page 30).
4. Confirm that your transducer is being properly cooled (see page 6).
5. Make sure that the horn is dry.
6. Wearing proper ear protection, hold the TEST key on the generator, read the displayed power and frequency values and record them in Table 6.
7. Add the reactor chamber and repeat steps 4 – 6 (with no liquid in the reactor chamber).

Test in water (batch mode)

1. Assemble the transducer and horn (see page 23) and secure the ultrasonic stack in the support stand (without the reactor chamber).
2. Plug the generator in a properly rated outlet and connect the ultrasound cable from the generator to the top of the transducer.
3. Set the amplitude on the generator to 80 % (see page 30).
4. Confirm that your transducer is being properly cooled (see page 6).
5. Insert the horn into a large (> 1 L) beaker of distilled water. The water temperature should be near 20 °C and the horn should be inserted into the liquid by 5 – 6 cm.
6. Wearing proper ear protection, hold the TEST key on the generator, read the displayed power and frequency values and record them in Table 6.

Test in water (flow-through mode)

1. Assemble the transducer, horn and reactor chamber (see pages 23 - 26) and secure the ultrasonic stack in the support stand.
2. Setup your processed liquid recirculation network (i.e., tubing, storage tank, pump and chiller, optionally provided by ISM) and begin recirculating water through the reactor chamber.
3. Plug the generator in a properly rated outlet and connect the ultrasound cable from the generator to the top of the transducer.
4. Set the amplitude on the generator to 80 % (see page 30).
5. Confirm that your transducer is being properly cooled (see page 6).
6. Stop to pause the recirculation of the water. Your reactor chamber should remain filled with water.
7. Wearing proper ear protection, hold the TEST key on the generator, read the displayed power and frequency values and record them in Table 6.

Ultrasonic Stack Power and Frequency Benchmarking

Each time you begin using a new ultrasonic horn, benchmark its frequency and power. This will allow you to track the performance of your horn over time. The first two rows in the table below are examples of how the information for each horn should be recorded.

Date	Transducer Serial No.	Horn Serial No.	Free Run Frequency [Hz]	Power at 80 % in Air [W]	Power at 80 % in Water [W]	Notes
01/12/2021	TR-SWCT-1200 01012025	HBHB-F20D30G4s 01012025	19,900 Hz	85 W	780 W	Benchmarking performed in the flow-through mode.
02/02/2021	TR-SWCT-1200 01012025	FBH-F20D35G3.8s 01012025	19,900 Hz	60 W	700 W	Benchmarking performed in the batch mode.

Table 6. Benchmarking the Ultrasonic Stack.